

Narrow Batten Clip System:

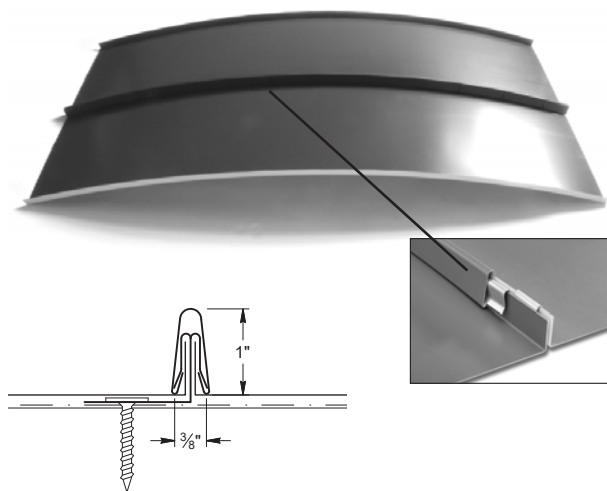

T-Panel™ Standing Seam with a Narrow Batten is perfect for radius roofing projects. This panel gives you the flexibility to design buildings with unique characteristics that only a radius panel can provide.

Wide Batten Clip System:

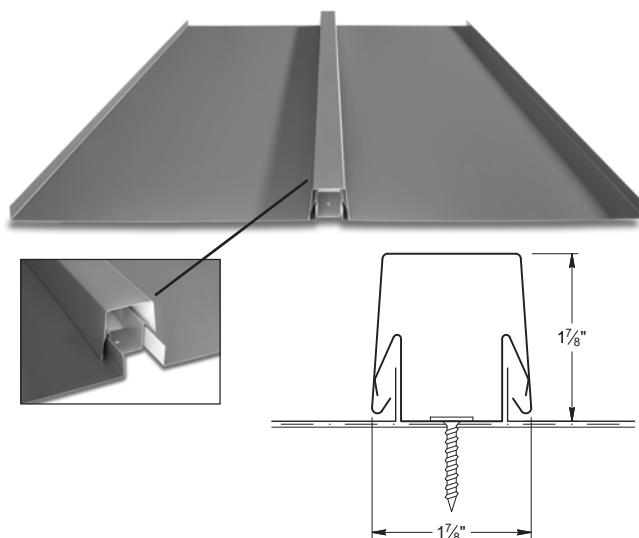

T-Panel™ with Wide Batten is ideal for creating a clean, wide pan appearance. This look adds dimension to any building type and accomplishes an eccentric architectural effect.

T-PANEL KEY FEATURES

- T-Panel™: 24 & 22 gauge Tru-Gauge™, .032 Aluminum, 16 & 20 oz. copper
- Vertical interlocking applications: allows installation from both directions starting at any location
- Tapered panels available

NARROW BATTEN KEY FEATURES

- T-Panel™ standard nominal width: 12", 16", and 20" (Please inquire for other coverage options)
- Narrow Batten: fabricated in 24 gauge steel, .032" aluminum and 16 & 20 oz. copper
- Narrow Batten: 1" vertical rib
- Factory and field radius of roof panels and Narrow Battens down to 4' radius
- Full length Narrow Battens are roll formed
- Narrow Batten incorporates nicely with 1" Snap Lock panels like Easy-Lock™, Streamline™, or Premier-Lock™ standing seam panel
- UL 790 Class A Fire rated & UL 2218 Class 4 Impact (hail) rated, UL580 Class 90 Wind Uplift rated for use with Narrow Batten
- UL Construction No. 344, 397 & 397A for use with Narrow Batten
- ASTM E1646/E331 Water Penetration and E1680/E283 Air Leakage Testing (coming in 2024)

- Standard panel lengths 2' to 60'
- 3:12 minimum pitch recommended
- Concealed fasteners: fasteners cannot leak
- Panel options: Striations, Accent Ribs, and Flat Pan

WIDE BATTEN KEY FEATURES

- T-Panel™ standard nominal width: 14" and 18" (Please inquire for other coverage options)
- Wide Batten: fabricated in 24 gauge steel, .032" aluminum and 16 & 20 oz. copper
- Wide Batten: 1-7/8" vertical rib
- Curving not available on Wide Batten profile
- Full length Wide Battens are roll formed
- Wide Batten incorporates nicely over Versa-Span™ standing seam panel (separate clip required)
- UL 790 Class A Fire rated & UL 2218 Class 4 Impact (hail) rated, UL580 Class 90 Wind Uplift rated for use with Wide Batten
- UL Construction No. 344, 397 & 397A for use with Wide Batten
- ASTM E1646/E331 Water Penetration and E1680/E283 Air Leakage Testing (coming in 2024)

MATERIAL SPECIFICATIONS

- 24 gauge Kynar 500® Painted Steel
G-90 Galvanized or AZ-50
- 22 & 24 gauge bare Zinalume® Plus AZ-55
(No finish warranty – 25 yr. perforation warranty)
- 22 gauge Kynar 500® Painted Steel
G-90 Galvanized or AZ-50
- .032" Kynar 500® Painted Aluminum
- 16 and 20 ounce Copper
(Please inquire)
- 22 gauge Rusteel™ Plus (A606)
- Kynar 500® and substrate testing data available
(See website)

FINISHES

- 21 Standard Colors, 5 Metallic Colors and 4 Specialized Colors
- Kynar 500® Paint System - the ultimate in exterior durability and color retention
- “Cool” color pigments are specially designed to reflect infrared light, reducing heat gain to dwelling, and conform with ENERGY STAR® criteria
- Superior quality, two coat, 70% resin finish, applied at a 1 mil. thickness
- 40 year residential paint warranty
- 20 and 30 year commercial paint warranty: Contact TMP for warranty specifications
- “Oil Canning” is an inherent characteristic of roof and wall products, and not a defect, which is not a cause for panel rejection

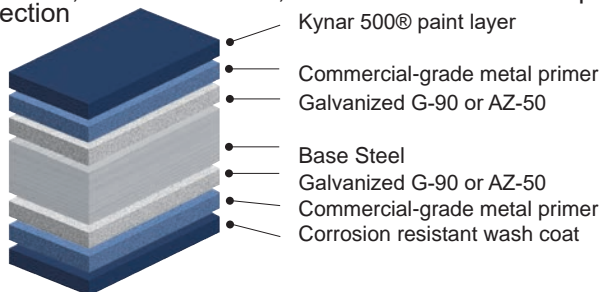

STANDARD COOL KYNAR 500® COLORS

40-Year Residential / 20 and 30 Year Commercial Manufacturer's Limited Warranty

▲ 22 Tru-Gauge™

◆ .032 Aluminum

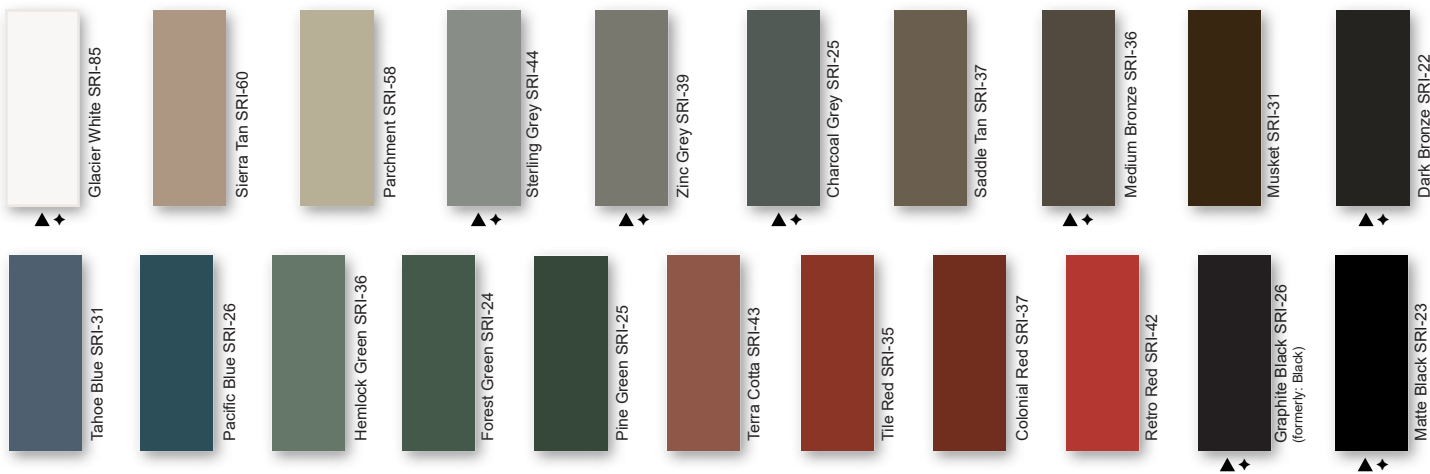

PREMIUM METALLIC COOL KYNAR® COLORS

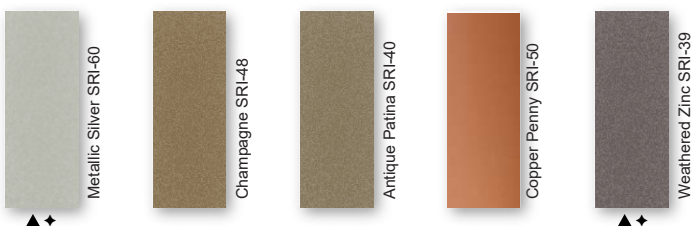

SPECIALIZED MATERIAL

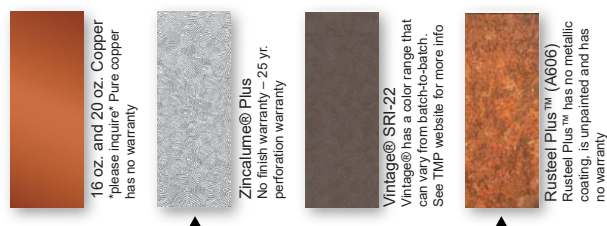

These printed chips provide a close representation of the colors.

Metal samples are available upon request. Coatings are low gloss 10-15% sheen.
SRI = Solar Reflective Index. SRI values listed above are in accordance with ASTM E 1980 and are based on actual testing. ***Oil canning is not a cause for material rejection***



Rev. Date 08-24