

ICC-ES Evaluation Report

ESR-5045

Issued April 2024

This report also contains:

- CBC Supplement

Subject to renewal April 2025

- LABC Supplement

ICC-ES Evaluation Reports are not to be construed as representing aesthetics or any other attributes not specifically addressed, nor are they to be construed as an endorsement of the subject of the report or a recommendation for its use. There is no warranty by ICC Evaluation Service, LLC, express or implied, as to any finding or other matter in this report, or as to any product covered by the report.

Copyright © 2024 ICC Evaluation Service, LLC. All rights reserved.

<p>DIVISION: 07 00 00— THERMAL AND MOISTURE PROTECTION</p> <p>Section: 07 46 16— Aluminum Siding</p> <p>Section: 07 46 19—Steel Siding</p>	<p>REPORT HOLDER: TAYLOR METAL INC. (dba TAYLOR METAL PRODUCTS)</p>	<p>EVALUATION SUBJECT: TMP METAL SIDING</p>	
---	---	---	---

1.0 EVALUATION SCOPE

1.1 Compliance with the following codes:

- 2021 and 2018 [International Building Code® \(IBC\)](#)
- 2021 and 2018 [International Residential Code® \(IRC\)](#)

For evaluation for compliance with codes adopted by [Los Angeles Department of Building and Safety \(LADBS\)](#), see [ESR-5045 LABC and LARC Supplement](#).

For evaluation for compliance with codes adopted by California Office of Statewide Health Planning and Development (OSHPD) AKA: California Department of Health Care Access and Information (HCAI) and the Division of State Architect (DSA), see [ESR-5045 CBC and CRC Supplement](#)

Properties evaluated:

- Structural
- Transverse wind load
- Air Leakage
- Water Resistance

1.2 Evaluation of the following green code:

- 2019 [California Green Building Standards Code \(CALGreen\)](#), Title 24, Part 11

Attributes verified:

See Section 3.1.

2.0 USES

The TMP metal siding are used as an exterior veneer on exterior walls and soffits of all types of construction.

3.0 DESCRIPTION

3.1 General: The TMP metal siding (panels) are formed from cold-formed steel or aluminum conforming to the product specifications, galvalume or zinc coatings, and base-metal thicknesses noted in [Table 1](#). The clips used to attach the siding to the supporting wall structure are made from materials conforming to the product specifications and base metal thicknesses noted in [Table 2](#). See [Figures 1-1](#) through [1-39](#) for metal siding. See [Figures 2](#) and [3](#) for clip details.

The attributes of the metal siding have been verified as conforming to the provisions of CALGreen Section A5.406.1.2 for reduced maintenance. Note that decisions on compliance for those areas rest with the user of this report. The user is advised of the project-specific provisions that may be contingent upon meeting specific conditions, and the verification of those conditions is outside the scope of this report. These codes or standards often provide supplemental information as guidance.

3.2 Supporting Members: The metal siding must be supported and attached to either cold-formed steel or wood supports as described in Section 3.2.1 and 3.2.2.

3.2.1 Cold-formed Steel Framing: The cold-formed steel framing members supporting the siding are C-shaped, Z-shaped or Hat-shaped, fabricated from a minimum 16 ga. [0.054-inch (1.372 mm) base-metal thickness) sheet steel, conforming to ASTM A653, minimum Grade 50 with a G90 zinc coating designation. The attachment of the siding to the steel support and the attachment of the steel support to the structure must be designed by registered design professional.

3.2.2 Wood Support: The wood members supporting the siding must be dimensional lumber or plywood sheathing. The plywood sheathing must have a minimum thickness of $1\frac{5}{32}$ -inch (11.9 mm) and a minimum span rating of 24/16, conforming to US DOC PS-1 in accordance with IBC Table 2303.1.5. The attachment of the siding to the wood support and the wood support to the structure must be designed by registered design professional.

3.3 Fasteners: The fasteners used to attach the metal siding to the supporting members must be corrosion resistant screws and sized as determined by the registered design professional. See [Figures 1-1](#) through [1-39](#) and [Table 3](#) for additional information.

4.0 DESIGN AND INSTALLATION

4.1 Design: The allowable wind pressures reported in [Figures 1-1](#) through [1-39](#) must not be exceeded. The wall structure supporting the siding must be designed by a registered design professional to resist the applied forces resulting from the siding.

4.2 Installation:

4.2.1 General: Installation of the TMP metal siding must be in accordance with this report, IBC Section 1404.11 or IRC Section R703.3 and Table R703.3(1), and the manufacturer's published installation instructions. The manufacturer's installation instructions must be available at the jobsite at all times during installation.

The siding must be installed in accordance with the details provided in [Figures 1-1](#) through [1-39](#) and [Table 3](#) of this report. Siding panels may be installed vertically or horizontally.

4.2.2 Water-resistive barrier: Where required by code, a code-complying water-resistive barrier must be installed behind the siding.

4.2.3 Air Leakage: When tested in accordance with ASTM E283, the wall assembly constructed using the metal siding has an air leakage rate as indicated in [Table 3](#) of this report. The siding must be installed in accordance with the provisions included in [Table 3](#) of this report. The sidelap of the siding must be sealed with butyl tape or caulking sealant in accordance with manufacturer's installation instructions.

4.2.4 Water Resistance: When tested in accordance with ASTM E331, the wall assembly constructed using the metal siding show no water penetration as indicated in [Table 3](#) of this report when subjected to a test period of 15 minutes. The siding must be installed in accordance with the provisions included in [Table 3](#) of this report. The sidelap of the siding must be sealed with butyl tape or caulking sealant in accordance with manufacturer's installation instructions

5.0 CONDITIONS OF USE:

The Taylor Metal Products metal siding described in this report comply with, or are suitable alternatives to what is specified in, those codes listed in Section 1.0 of this report, subject to the following conditions:

- 5.1** Installation must comply with the applicable code, this report and the manufacturer's published installation instructions. In the event of conflict between this report and the manufacturer's instructions, the most stringent governs.
- 5.2** A water-resistive barrier must be provided as required by the applicable code.

- 5.3 For the steel siding, where installed on noncombustible substrate (such as steel, concrete or masonry) of exterior walls greater than 40 feet in Types I, II, III or IV construction and the only combustible material is the water-resistive barrier, the water-resistive barrier must comply with Exception 1 of IBC Section 1402.5. For the aluminum siding, where installed on noncombustible substrate (such as steel, concrete or masonry) of exterior walls greater than 40 feet in Types I, II, III or IV construction and the only combustible material is the water-resistive barrier, the water-resistive barrier must comply with Exception 2 of IBC Section 1402.5.
- 5.4 Design wind pressures must not exceed the allowable wind pressures listed in [Figures 1-1](#) through [1-39](#).
- 5.5 The allowable wind pressures listed in [Figures 1-1](#) through [1-39](#) are for the siding only. The wall structure to which the siding is attached must be designed by a registered design professional for the applicable components and cladding wind loads in accordance with the IBC or IRC, as applicable.
- 5.6 Calculations demonstrating that the required wind resistance is less than the allowable wind resistance must be submitted to the code official.
- 5.7 The metal siding are manufactured under an approved quality control program with inspections by ICC-ES.

6.0 EVIDENCE SUBMITTED

- 6.1 Manufacturer's product brochures and installation instructions.
- 6.2 Engineering calculations by a registered design professional.
- 6.3 Data in accordance with ASTM E136, ASTM E330, ASTM E1592, ASTM E283 and ASTM E331.
- 6.4 Quality documentation in accordance with the [ICC-ES Acceptance Criteria for Quality Documentation \(AC10\)](#).

7.0 IDENTIFICATION

- 7.1 The ICC-ES mark of conformity, electronic labeling, or the evaluation report number (ICC-ES ESR-5045) along with the name, registered trademark, or registered logo of the report holder must be included in the product label.
- 7.2 In addition, the siding are identified with a label bearing the product name, the material type and the manufacturer's name (Taylor Metal, Inc.).
- 7.3 The report holder's contact information is the following:

TAYLOR METAL, INC.(dba TAYLOR METAL PRODUCTS)
4566 RIDGE DRIVE NE
SALEM, OREGON 97301
(503) 581-8338
www.taylormetal.com

TABLE 1—TAYLOR METAL SIDING SPECIFICATIONS

PANEL	MATERIAL			MIN. BASE METAL THICKNESS (inch)
	Specification	Classification	Coating	
PBR 36" width	ASTM A792 ASTM A653	SS Grade 50 SS Grade 80 (26 gauge only)	AZ50-Painted AZ55-Unpainted G90	0.018 (26 gauge) 0.0224 (24 gauge) 0.0281 (22 gauge)
	ASTM B209	3003-H14	N/A	0.032
HR-34 34" width	ASTM A792 ASTM A653	SS Grade 50 SS Grade 80 (26 gauge only) SS Grade 33 (20 gauge only)	AZ50- Painted AZ55- Unpainted G90	0.018 (26 gauge) 0.0224 (24 gauge) 0.0281 (22 gauge) 0.0341 (20 gauge)
	ASTM B209	3003-H14	N/A	0.032 0.040
Classic 7/8 Corrugated 37.33" width	ASTM A792 ASTM A653	SS Grade 50 SS Grade 80 (26 gauge only)	AZ50- Painted AZ55- Unpainted G90	0.018 (26 gauge) 0.0224 (24 gauge) 0.0281 (22 gauge)
	ASTM B209	3003-H14	N/A	0.032
BR-36 36" width	ASTM A792 ASTM A653	SS Grade 50 SS Grade 33 (20 and 18 gauge only)	AZ50- Painted AZ55- Unpainted G90	0.0224 (24 gauge) 0.0281 (22 gauge) 0.0341 (20 gauge) 0.0451 (18 gauge)
	ASTM B209	3003-H14	N/A	0.032 0.040 0.050
Contour Series C-5 12" width	ASTM A792 ASTM A653	SS Grade 50 SS Grade 33 (20 and 18 gauge only)	AZ50- Painted AZ55- Unpainted G90	0.0224 (24 gauge) 0.0281 (22 gauge) 0.0359 (20 gauge) 0.0451 (18 gauge)
	ASTM B209	3003-H14	N/A	0.032 0.040
Contour Series C-7/CR-A 12" width	ASTM A792 ASTM A653	SS Grade 50 SS Grade 33 (20 and 18 gauge only)	AZ50- Painted AZ55- Unpainted G90	0.0224 (24 gauge) 0.0281 (22 gauge) 0.0359 (20 gauge) 0.0451 (18 gauge)
	ASTM B209	3003-H14	N/A	0.032 0.040
Contour Series C-8 12" width	ASTM A792 ASTM A653	SS Grade 50 SS Grade 33 (20 and 18 gauge only)	AZ50- Painted AZ55- Unpainted G90	0.0224 (24 gauge) 0.0281 (22 gauge) 0.0359 (20 gauge) 0.0451 (18 gauge)
	ASTM B209	3003-H14	N/A	0.032 0.040
Contour Series C-1/CE-A 16" width	ASTM A792 ASTM A653	SS Grade 50 SS Grade 33 (20 and 18 gauge only)	AZ50- Painted AZ55- Unpainted G90	0.0224 (24 gauge) 0.0281 (22 gauge) 0.0359 (20 gauge) 0.0451 (18 gauge)
	ASTM B209	3003-H14	N/A	0.032 0.040
Contour Series C-B (CE-B) 16" width	ASTM A792 ASTM A653	SS Grade 50 SS Grade 33 (20 and 18 gauge only)	AZ50 Painted AZ55- Unpainted G90	0.0224 (24 gauge) 0.0281 (22 gauge) 0.0341 (20 gauge) 0.0451 (18 gauge)
	ASTM B209	3003-H14	N/A	0.032 0.040
Contour Series C-C (CE-C) 16" width	ASTM A792 ASTM A653	SS Grade 50 SS Grade 33 (20 and 18 gauge only)	AZ50 Painted AZ55- Unpainted G90	0.0224 (24 gauge) 0.0281 (22 gauge) 0.0341 (20 gauge) 0.0451 (18 gauge)

PANEL	MATERIAL			MIN. BASE METAL THICKNESS (inch)
	Specification	Classification	Coating	
Contour Series C-D (CE-D) 12" width	ASTM A792 ASTM A653	SS Grade 50 SS Grade 33 (20 and 18 gauge only)	AZ50 Painted AZ55- Unpainted G90	0.0224 (24 gauge) 0.0281 (22 gauge) 0.0341 (20 gauge) 0.0451 (18 gauge)
Contour Series C-E (CE-E) 8" width	ASTM A792 ASTM A653	SS Grade 50 SS Grade 33 (20 and 18 gauge only)	AZ50 Painted AZ55- Unpainted G90	0.0224 (24 gauge) 0.0281 (22 gauge) 0.0341 (20 gauge) 0.0451 (18 gauge)
Contour Series C1-A 16" width	ASTM A792 ASTM A653	SS Grade 50 SS Grade 33 (20 and 18 gauge only)	AZ50 Painted AZ55- Unpainted G90	0.0224 (24 gauge) 0.0281 (22 gauge) 0.0341 (20 gauge) 0.0451 (18 gauge)
	ASTM B209	3003-H14	N/A	0.032 0.040
Contour Series C1-B 12" width	ASTM A792 ASTM A653	SS Grade 50 SS Grade 33 (20 and 18 gauge only)	AZ50 Painted AZ55- Unpainted G90	0.0224 (24 gauge) 0.0281 (22 gauge) 0.0341 (20 gauge) 0.0451 (18 gauge)
	ASTM B209	3003-H14	N/A	0.032 0.040
Contour Series C1-C 16" width	ASTM A792 ASTM A653	SS Grade 50 SS Grade 33 (20 and 18 gauge only)	AZ50 Painted AZ55- Unpainted G90	0.0224 (24 gauge) 0.0281 (22 gauge) 0.0341 (20 gauge) 0.0451 (18 gauge)
	ASTM B209	3003-H14	N/A	0.032 0.040
Contour Series C1-D 12" width	ASTM A792 ASTM A653	SS Grade 50 SS Grade 33 (20 and 18 gauge only)	AZ50 Painted AZ55- Unpainted G90	0.0224 (24 gauge) 0.0281 (22 gauge) 0.0341 (20 gauge) 0.0451 (18 gauge)
Contour Series C-2 16" width	ASTM A792 ASTM A653	SS Grade 50 SS Grade 33 (20 and 18 gauge only)	AZ50 Painted AZ55- Unpainted G90	0.0224 (24 gauge) 0.0281 (22 gauge) 0.0341 (20 gauge) 0.0451 (18 gauge)
	ASTM B209	3003-H14	N/A	0.032 0.040
Contour Series C2-A 12" width	ASTM A792 ASTM A653	SS Grade 50 SS Grade 33 (20 and 18 gauge only)	AZ50 Painted AZ55- Unpainted G90	0.0224 (24 gauge) 0.0281 (22 gauge) 0.0341 (20 gauge) 0.0451 (18 gauge)
Contour Series C2-B 12" width	ASTM A792 ASTM A653	SS Grade 50 SS Grade 33 (20 and 18 gauge only)	AZ50 Painted AZ55- Unpainted G90	0.0224 (24 gauge) 0.0281 (22 gauge) 0.0341 (20 gauge) 0.0451 (18 gauge)
Contour Series C2-C 12" width	ASTM A792 ASTM A653	SS Grade 50 SS Grade 33 (20 and 18 gauge only)	AZ50 Painted AZ55- Unpainted G90	0.0224 (24 gauge) 0.0281 (22 gauge) 0.0341 (20 gauge) 0.0451 (18 gauge)
Contour Series C-3 16" width	ASTM A792 ASTM A653	SS Grade 50 SS Grade 33 (20 and 18 gauge only)	AZ50 Painted AZ55- Unpainted G90	0.0224 (24 gauge) 0.0281 (22 gauge) 0.0341 (20 gauge) 0.0451 (18 gauge)
	ASTM B209	3003-H14	N/A	0.032 0.040

PANEL	MATERIAL			MIN. BASE METAL THICKNESS (inch)
	Specification	Classification	Coating	
Contour Series C-4 16" width	ASTM A792 ASTM A653	SS Grade 50 SS Grade 33 (20 and 18 gauge only)	AZ50 Painted AZ55- Unpainted G90	0.0224 (24 gauge) 0.0281 (22 gauge) 0.0341 (20 gauge) 0.0451 (18 gauge)
Contour Series C5-A 16" width	ASTM A792 ASTM A653	SS Grade 50 SS Grade 33 (20 and 18 gauge only)	AZ50 Painted AZ55- Unpainted G90	0.0224 (24 gauge) 0.0281 (22 gauge) 0.0341 (20 gauge) 0.0451 (18 gauge)
Contour Series C-6 16" width	ASTM A792 ASTM A653	SS Grade 50 SS Grade 33 (20 and 18 gauge only)	AZ50 Painted AZ55- Unpainted G90	0.0224 (24 gauge) 0.0281 (22 gauge) 0.0341 (20 gauge) 0.0451 (18 gauge)
	ASTM B209	3003-H14	N/A	0.032 0.040
Contour Series C6-A 12" width	ASTM A792 ASTM A653	SS Grade 50 SS Grade 33 (20 and 18 gauge only)	AZ50 Painted AZ55- Unpainted G90	0.0224 (24 gauge) 0.0281 (22 gauge) 0.0341 (20 gauge) 0.0451 (18 gauge)
Contour Series C8-A 12" width	ASTM A792 ASTM A653	SS Grade 50 SS Grade 33 (20 and 18 gauge only)	AZ50 Painted AZ55- Unpainted G90	0.0224 (24 gauge) 0.0281 (22 gauge) 0.0341 (20 gauge) 0.0451 (18 gauge)
	ASTM B209	3003-H14	N/A	0.032 0.040
Contour Series C8-B 16" width	ASTM A792 ASTM A653	SS Grade 50 SS Grade 33 (20 and 18 gauge only)	AZ50 Painted AZ55- Unpainted G90	0.0224 (24 gauge) 0.0281 (22 gauge) 0.0341 (20 gauge) 0.0451 (18 gauge)
Contour Series CR-B 12" width	ASTM A792 ASTM A653	SS Grade 50 SS Grade 33 (20 and 18 gauge only)	AZ50 Painted AZ55- Unpainted G90	0.0224 (24 gauge) 0.0281 (22 gauge) 0.0341 (20 gauge) 0.0451 (18 gauge)
Contour Series CR-C 12" width	ASTM A792 ASTM A653	SS Grade 50 SS Grade 33 (20 and 18 gauge only)	AZ50 Painted AZ55- Unpainted G90	0.0224 (24 gauge) 0.0281 (22 gauge) 0.0341 (20 gauge) 0.0451 (18 gauge)
Contour Series CR-D 12" width	ASTM A792 ASTM A653	SS Grade 50 SS Grade 33 (20 and 18 gauge only)	AZ50 Painted AZ55- Unpainted G90	0.0224 (24 gauge) 0.0281 (22 gauge) 0.0341 (20 gauge) 0.0451 (18 gauge)
Contour Series CR-E 12" width	ASTM A792 ASTM A653	SS Grade 50 SS Grade 33 (20 and 18 gauge only)	AZ50- Painted AZ55- Unpainted G90	0.0224 (24 gauge) 0.0281 (22 gauge) 0.0359 (20 gauge) 0.0451 (18 gauge)
	ASTM B209	3003-H14	N/A	0.032 0.040
Contour Series CR-F 12" width	ASTM A792 ASTM A653	SS Grade 50 SS Grade 33 (20 and 18 gauge only)	AZ50 Painted AZ55- Unpainted G90	0.0224 (24 gauge) 0.0281 (22 gauge) 0.0341 (20 gauge) 0.0451 (18 gauge)
SmoothWall 100 12" and 12 ⁵ / ₈ " widths	ASTM A792 ASTM A653	SS Grade 50	AZ50- Painted AZ55- Unpainted G90	0.0224 (24 gauge) 0.0281 (22 gauge) 0.0359 (20 gauge)
	ASTM B209	3003-H14	N/A	0.032

For SI: 1 inch = 25.4 mm.

TABLE 2—TAYLOR METAL ROOF PANEL CLIP SPECIFICATIONS

CLIP	MATERIAL			MIN. BASE STEEL THICKNESS (inch)
	Specification	Classification	Coating	
Standard Contour Clip	Galvanized Steel	18 ga. steel ASTM A653 Grade 50	G90	0.048
Standard Contour Express Clip	Galvanized Steel	18 ga. steel ASTM A653 Grade 50	G90	0.048
High Wind Clips (SWC-12) (SmoothWall/Lifetime Soffit)	Galvanized Steel	16 ga. steel ASTM A653 Grade 50	G90	0.054

For SI: 1 inch = 25.4 mm.

TABLE 3—AIR AND WATER LEAKAGE RESULTS FOR METAL SIDING PROFILES

TAYLOR METAL SIDING PANEL	SIDING SEAM INSTALLATION	AIR LEAKAGE RESULTS PER ASTM E283	WATER LEAKAGE RESULTS PER ASTM E331
36" wide PBR Prepainted 24 ga. G-90 Galvanized	No. 12 by 7/8-inch screws with nylon washers at 12 inches on center and continuous bead of butyl sealant installed per manufacturer's installation instructions	<0.01 cfm/ft ² at 25 psf	Pass at 50 psf for 15 minutes
36" wide BR-36 Prepainted 24 ga. G-90 Galvanized	No. 12 by 7/8-inch screws with nylon washers and continuous bead of butyl sealant installed per manufacturer's installation instructions	<0.01 cfm/ft ² at 25 psf	Pass at 50 psf for 15 minutes
37.33" wide Classic 7/8 Corrugated Prepainted 24 ga. G-90 Galvanized	No. 12 by 7/8-inch screws with nylon washers and continuous bead of butyl sealant installed per manufacturer's installation instructions	0.01 cfm/ft ² at 25 psf	Pass at 50 psf for 15 minutes
34" wide HR-34 Prepainted 24 ga. G-90 Galvanized	No. 12 by 7/8-inch screws with nylon washers and continuous bead of butyl sealant installed per manufacturer's installation instructions	<0.01 cfm/ft ² at 25 psf	Pass at 50 psf for 15 minutes
16" wide Contour Series C-1/CE-A (screw flange attachment) Prepainted 24 ga. G-90 Galvanized	Installation of siding per manufacturer's installation instructions with continuous bead of butyl sealant installed at seams per manufacturer's installation instructions	<0.01 cfm/ft ² at 12 psf	Pass at 20.5 psf for 15 minutes
16" wide Contour Series C-1/CE-A (clip attachment) Prepainted 24 ga. G-90 Galvanized	Installation of siding per manufacturer's installation instructions with continuous bead of butyl sealant installed at seams per manufacturer's installation instructions	0.07 cfm/ft ² at 12 psf	Pass at 20.5 psf for 15 minutes
12" wide SmoothWall Prepainted 24 ga. G-90 Galvanized	Installation of siding per manufacturer's installation instructions with continuous bead of butyl sealant installed per manufacturer's installation instructions	0.01 cfm/ft ² at 25 psf	Pass at 25 psf for 15 minutes

For SI: 1 inch= 25.4 mm, 1 cfm/ft²= 5.08 l/s*m², 1 psf= 47.9 Pa.

NOTES TO ALLOWABLE NEGATIVE AND POSITIVE LOAD TABLES SHOWN IN [FIGURES 1-1](#) THROUGH [1-39](#)

ALLOWABLE NEGATIVE LOAD TABLES

1. Theoretical section properties for steel panels have been calculated per AISI S100 Specification for the Design of Cold-Formed Steel Structural Members. Theoretical section properties for aluminum panels have been calculated per Aluminum Design Manual.
2. Tabulated allowable negative load values are based on ASTM E1592 testing divided by a factor of safety of 2.0.
3. Tabulated allowable negative loads do not consider panel connection to structural support. The fastener connection strength must be determined by registered design professional.
4. The panels must be supported in accordance with Section 3.2 of this report.
5. Panels must be installed with the fastener and/or clip configuration shown in the corresponding figures.
6. The panel span for the PBR, HR-34, Classic Corrugated 7/8 and BR-36 metal siding panels represent the maximum supporting structure spacing. The panel span for the Contour Series and SmoothWall metal siding panels represent the maximum spacing for attachment of the flange to supporting structure along the seam.

ALLOWABLE POSITIVE LOAD TABLES

1. Theoretical section properties for Steel panels have been calculated per 2020 AISI S100 North American Specification for the Design of Cold-Formed Steel Structural Member. I_{xx} and S_{xx} are effective section properties for deflection and bending.
2. Theoretical section properties for Aluminum panels have been calculated per 2020 Aluminum Design Manual (ADM). I_{xx} and S_{xx} are effective section properties for deflection and bending.
3. Tabulated allowable loads for Steel panels are calculated in accordance with 2020 AISI S100 specifications considering bending, shear, combined bending and shear and deflection. Tabulated allowable load considers a 3 or more equal span condition.
4. Tabulated allowable load does not address panel weight, fasteners, connection strength of supporting member. The connection of the panels to structural supports must be designed by registered design professional.
5. Allowable load includes web crippling. The panels are assumed to bear on a minimum support width of 2.5 inches (63 mm).
6. Tabulated load values are based on deflection limit at $L/60$ in accordance with IBC Table 1604.3.
7. Tabulated allowable load values are based on analysis in accordance with 2020 AISI S100 and 2020 ADM.
8. No further increases are permitted to tabulated load values.
9. When panels are installed over solid or closely fitted sheathing, the capacity is limited to the capacity of the underlying sheathing.
10. The panel span for the PBR, HR-34, Classic Corrugated 7/8 and BR-36 metal siding panels represent the maximum supporting structure spacing. The panel span for the Contour Series and SmoothWall metal siding panels represent the maximum spacing for attachment of the flange to supporting structure along the seam.

PBR

Panel profile and Fastening Schedule

Minimum six (6) No. 12 hex-head screws across the panel width at all supports. Sidelap fasteners are No. 14 hex head screw, Lap Tek self-drilling screws at 12" OC.

NEGATIVE LOAD

				SECTION PROPERTIES						ALLOWABLE UNIFORM LOADS, psf For various clip spacings (i.e. span values)						
Width, in.	Gauge	Yield ksi	Weight psf	Top in Compression			Bottom in Compression			Negative Load						
				I_{xx} in ⁴ /ft.	I_{xx} (eff) in ⁴ /ft.	S_{xx} in ³ /ft.	I_{xx} in ⁴ /ft.	I_{xx} (eff) in ⁴ /ft.	S_{xx} in ³ /ft.	2'	2.5'	3'	3.5	4'	4.5'	5'
36	26	80	0.85	0.0453	0.0399	0.0448	0.0267	0.0321	0.0391	100.0	92.5	85.0	77.5	70.0	62.5	55.0
36	24	50	1.19	0.0633	0.0555	0.0639	0.0363	0.0441	0.0553	175.0	156.7	138.3	120.0	101.7	83.3	65.0
36	22	50	1.51	0.0867	0.0761	0.0989	0.0500	0.0606	0.0751	200.0	178.3	156.7	135.0	113.3	91.7	70.0
36	0.032"	19	0.52	0.0967	0.0967	0.0990	0.0967	0.0967	0.3023	187.5	165.5	143.3	121.3	99.2	77.1	55.0

POSITIVE LOAD

				SECTION PROPERTIES						ALLOWABLE UNIFORM LOADS, psf For various clip spacings (i.e. span values)									
Width, in.	Gauge	Yield ksi	Weight psf	Top in Compression			Bottom in Compression			Positive Load									
				I_{xx} in ⁴ /ft.	I_{xx} (eff) in ⁴ /ft.	S_{xx} in ³ /ft.	I_{xx} in ⁴ /ft.	I_{xx} (eff) in ⁴ /ft.	S_{xx} in ³ /ft.	2'	2.5'	3'	3.5	4'	4.5'	5'	5.5'	6'	8'
36	26	80	0.85	0.0453	0.0399	0.0448	0.0267	0.0321	0.0391	192.3	153.8	128.2	109.9	96.1	77.2	62.6	51.7	43.4	24.4
36	24	50	1.19	0.0633	0.0555	0.0639	0.0363	0.0441	0.0553	191.4	153.1	127.6	109.4	86.4	68.3	55.3	45.7	38.4	21.6
36	22	50	1.51	0.0867	0.0761	0.0989	0.0500	0.0606	0.0751	306.4	245.1	204.2	153.3	117.3	92.7	75.1	62.1	52.2	29.3
36	0.032"	19	0.52	0.0967	0.0967	0.0990	0.0967	0.0967	0.3023	40.4	32.3	26.9	23.1	20.2	17.9	16.2	14.7	13.5	10.1

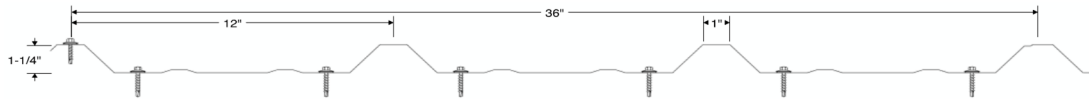

FIGURE 1-1 PBR PANEL

HR-34

Panel profile and Fastening Schedule

Minimum three (3) No. 12 hex-head screws across the panel width at all supports. Sidelap fasteners are No. 14 hex head screw, Lap Tek self-drilling screws at 12" OC.

NEGATIVE LOAD

				SECTION PROPERTIES						ALLOWABLE UNIFORM LOADS, psf For various clip spacings (i.e. span values)						
Width, in.	Gauge	Yield ksi	Weight psf	Top in Compression			Bottom in Compression			Negative Load						
				I_{xx} in ⁴ /ft.	I_{xx} (eff) in ⁴ /ft.	S_{xx} in ³ /ft.	I_{xx} in ⁴ /ft.	I_{xx} (eff) in ⁴ /ft.	S_{xx} in ³ /ft.	2'	2.5'	3'	3.5'	4'	4.5'	5'
34	26	80	0.96	0.0702	0.0694	0.0699	0.0675	0.0683	0.0830	87.5	80.4	73.3	66.3	59.2	52.1	45.0
34	24	50	1.18	0.1060	0.1067	0.1233	0.1085	0.1078	0.1337	100.0	90.8	81.7	72.5	63.3	54.2	45.0
34	22	50	1.46	0.1307	0.1317	0.1539	0.1343	0.1333	0.1681	100.0	90.8	81.7	72.5	63.3	54.2	45.0
34	20	33	1.76	0.1767	0.1777	0.2140	0.1802	0.1792	0.2200	105.0	95.8	86.7	77.5	68.3	59.2	50.0
34	0.032"	19	0.52	0.1690	0.1690	0.2390	0.1690	0.1690	0.2070	112.5	100.8	89.7	78.5	67.3	56.2	45.0
34	0.040"	19	0.65	0.2120	0.2120	0.2970	0.2120	0.2120	0.2570	100.0	90.0	80.0	70.0	60.0	50.0	40.0

POSITIVE LOAD

				SECTION PROPERTIES						ALLOWABLE UNIFORM LOADS, psf For various clip spacings (i.e. span values)									
Width, in.	Gauge	Yield ksi	Weight psf	Top in Compression			Bottom in Compression			Positive Load									
				I_{xx} in ⁴ /ft.	I_{xx} (eff) in ⁴ /ft.	S_{xx} in ³ /ft.	I_{xx} in ⁴ /ft.	I_{xx} (eff) in ⁴ /ft.	S_{xx} in ³ /ft.	2'	2.5'	3'	3.5	4'	4.5'	5'	5.5'	6'	8'
34	26	80	0.96	0.0702	0.0694	0.0699	0.0675	0.0683	0.0830	234.6	187.6	156.4	134.0	117.3	104.2	93.8	85.3	77.7	43.7
34	24	50	1.18	0.1060	0.1067	0.1233	0.1085	0.1078	0.1337	243.6	194.9	162.4	139.2	121.8	108.3	97.5	88.6	81.2	48.2
34	22	50	1.46	0.1307	0.1317	0.1539	0.1343	0.1333	0.1681	318.2	254.6	212.1	181.8	159.1	141.4	127.3	115.7	106.1	60.1
34	20	33	1.76	0.1767	0.1777	0.2140	0.1802	0.1792	0.2200	380.0	304.0	253.3	217.1	190.0	168.9	142.7	117.9	99.1	55.7
34	0.032"	19	0.52	0.1690	0.1690	0.2390	0.1690	0.1690	0.2070	63.2	50.6	42.1	36.1	31.6	28.1	25.3	22.9	21.1	
34	0.040"	19	0.65	0.2120	0.2120	0.2970	0.2120	0.2120	0.2570	98.6	78.9	65.8	56.4	49.3	43.8	39.5	35.9	32.9	24.7

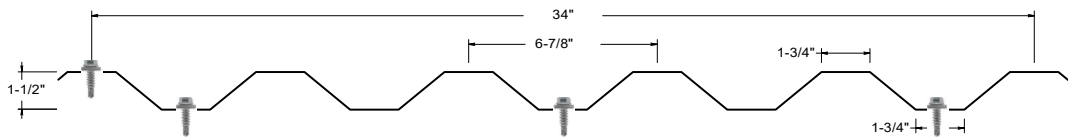

FIGURE 1-2 HR-34 PANELS (3 SCREWS)

HR-34

Panel profile and Fastening Schedule

Minimum five (5) No. 12 hex-head screws across the panel width at all supports. Sidelap fasteners are No. 14 hex head screw, Lap Tek self-drilling screws at 12" OC.

NEGATIVE LOAD

				SECTION PROPERTIES						ALLOWABLE UNIFORM LOADS, psf For various clip spacings (i.e. span values)						
Width, in.	Gauge	Yield ksi	Weight psf	Top in Compression			Bottom in Compression			Negative Load						
				I_{xx} in ⁴ /ft.	$I_{xx(eff)}$ in ⁴ /ft.	S_{xx} in ³ /ft.	I_{xx} in ⁴ /ft.	$I_{xx(eff)}$ in ⁴ /ft.	S_{xx} in ³ /ft.	2'	2.5'	3'	3.5'	4'	4.5'	5'
34	26	80	0.96	0.0702	0.0694	0.0699	0.0675	0.0683	0.0830	175.0	157.5	140.0	122.5	105.0	87.5	70.0
34	24	50	1.18	0.1060	0.1067	0.1233	0.1085	0.1078	0.1337	200.0	180.0	160.0	140.0	120.0	100.0	80.0
34	22	50	1.46	0.1307	0.1317	0.1539	0.1343	0.1333	0.1681	200.0	178.3	156.7	135.0	113.3	91.7	70.0
34	20	33	1.76	0.1767	0.1777	0.2140	0.1802	0.1792	0.2200	200.0	179.2	158.3	137.5	116.7	95.8	75.0
34	0.032"	19	0.52	0.1690	0.1690	0.2390	0.1690	0.1690	0.2070	120.0	108.3	96.7	85.0	73.3	61.7	50.0
34	0.040"	19	0.65	0.2120	0.2120	0.2970	0.2120	0.2120	0.2570	200.0	177.1	154.2	131.3	108.3	85.4	62.5

POSITIVE LOAD

				SECTION PROPERTIES						ALLOWABLE UNIFORM LOADS, psf For various clip spacings (i.e. span values)									
Width, in.	Gauge	Yield ksi	Weight psf	Top in Compression			Bottom in Compression			Positive Load									
				I_{xx} in ⁴ /ft.	$I_{xx(eff)}$ in ⁴ /ft.	S_{xx} in ³ /ft.	I_{xx} in ⁴ /ft.	$I_{xx(eff)}$ in ⁴ /ft.	S_{xx} in ³ /ft.	2'	2.5'	3'	3.5'	4'	4.5'	5'	5.5'	6'	8'
34	26	80	0.96	0.0702	0.0694	0.0699	0.0675	0.0683	0.0830	234.6	187.6	156.4	134.0	117.3	104.2	93.8	85.3	77.7	43.7
34	24	50	1.18	0.1060	0.1067	0.1233	0.1085	0.1078	0.1337	243.6	194.9	162.4	139.2	121.8	108.3	97.5	88.6	81.2	48.2
34	22	50	1.46	0.1307	0.1317	0.1539	0.1343	0.1333	0.1681	318.2	254.6	212.1	181.8	159.1	141.4	127.3	115.7	106.1	60.1
34	20	33	1.76	0.1767	0.1777	0.2140	0.1802	0.1792	0.2200	380.0	304.0	253.3	217.1	190.0	168.9	142.7	117.9	99.1	55.7
34	0.032"	19	0.52	0.1690	0.1690	0.2390	0.1690	0.1690	0.2070	63.2	50.6	42.1	36.1	31.6	28.1	25.3	22.9	21.1	
34	0.040"	19	0.65	0.2120	0.2120	0.2970	0.2120	0.2120	0.2570	98.6	78.9	65.8	56.4	49.3	43.8	39.5	35.9	32.9	24.7

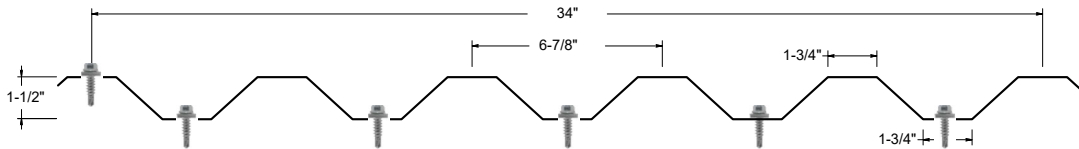

FIGURE 1-3 HR-34 PANELS (5 SCREWS)

Classic Corrugated

Panel profile and Fastening Schedule

Minimum five (5) No. 12 hex-head screws across the panel width at all supports. Sidelap fasteners are No. 14 hex head screw, Lap Tek self-drilling screws at 12" OC.

NEGATIVE LOAD

				SECTION PROPERTIES				ALLOWABLE UNIFORM LOADS, psf For various clip spacings (i.e. span values)						
Width, in.	Gauge	Yield ksi	Weight psf	Top in Compression		Bottom in Compression		Negative Load						
				I_{xx} in ⁴ /ft.	S_{xx} in ³ /ft.	I_{xx} in ⁴ /ft.	S_{xx} in ³ /ft.	2'	2.5'	3'	3.5'	4'	4.5'	5'
36	26	80	1.02	0.0250	0.0570	0.0250	0.0570	110.0	100.4	90.8	81.3	71.7	62.1	52.5
36	24	50	1.33	0.0240	0.0777	0.0240	0.0777	117.5	108.3	99.2	90.0	80.8	71.7	62.5
36	22	50	1.73	0.0400	0.0914	0.0400	0.0914	150.0	135.4	120.8	106.3	91.7	77.1	62.5
36	0.032"	19	0.451	0.0450	0.1030	0.0450	0.1030	55.0	50.8	46.7	42.5	38.3	34.2	30.0

POSITIVE LOAD

				SECTION PROPERTIES						ALLOWABLE UNIFORM LOADS, psf For various clip spacings (i.e. span values)									
Width, in.	Gauge	Yield ksi	Weight psf	Top in Compression			Bottom in Compression			Positive Load									
				I_{xx} in ⁴ /ft.	$I_{xx(eff)}$ in ⁴ /ft.	S_{xx} in ³ /ft.	I_{xx} in ⁴ /ft.	$I_{xx(eff)}$ in ⁴ /ft.	S_{xx} in ³ /ft.	2'	2.5'	3'	3.5'	4'	4.5'	5'	5.5'	6'	
36	26	80	1.02	0.0250	0.0250	0.0570	0.0250	0.0250	0.0570	356.3	228.0	158.3	116.3	89.1	70.4	57.0			
36	24	50	1.33	0.0240	0.0240	0.0777	0.0240	0.0240	0.0777	485.6	310.8	215.8	158.6	121.4	95.9	77.7	64.2	54.0	
36	22	50	1.73	0.0400	0.0400	0.0914	0.0400	0.0400	0.0914	571.3	365.6	253.9	186.5	142.8	112.8	91.4	75.5	63.5	
36	0.032"	19	0.451	0.0450	0.0450	0.1030	0.0450	0.0450	0.1030	244.6	156.6	108.7	79.9	61.2	48.3				

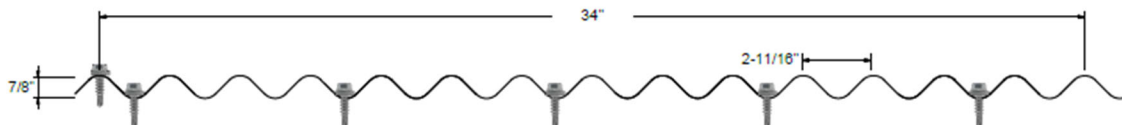

FIGURE 1-4 CLASSIC CORRUGATED PANELS (5 SCREWS)

Classic Corrugated

Panel profile and Fastening Schedule

Minimum seven (7) No. 12 hex-head screws across the panel width at all supports.

Sidlap fasteners are No. 14 hex head screw, Lap Tek self-drilling screws at 12" OC.

NEGATIVE LOAD

				SECTION PROPERTIES				ALLOWABLE UNIFORM LOADS, psf For various clip spacings (i.e. span values)								
Width, in.	Gauge	Yield ksi	Weight psf	Top in Compression			Bottom in Compression			Negative Load						
				I_{xx} in ⁴ /ft	I_{xx} (eff) in ⁴ /ft	S_{xx} in ³ /ft	I_{xx} in ⁴ /ft	I_{xx} (eff) in ⁴ /ft	S_{xx} in ³ /ft	2'	2.5'	3'	3.5'	4'	4.5'	5'
36	26	80	1.02	0.0250	0.0570	0.0250	0.0250	0.0570	162.5	162.5	162.5	162.5	162.5	162.5	162.5	
36	24	50	1.33	0.0240	0.0777	0.0240	0.0240	0.0777	162.5	108.3	99.2	90.0	80.8	71.7	75.0	
36	22	50	1.73	0.0400	0.0914	0.0400	0.0400	0.0914	175.0	135.4	120.8	106.3	91.7	77.1	75.0	
36	0.032"	19	0.451	0.0450	0.1030	0.0450	0.0450	0.1030	175.0	155.0	135.0	115.0	95.0	75.0	55.0	

POSITIVE LOAD

				SECTION PROPERTIES						ALLOWABLE UNIFORM LOADS, psf For various clip spacings (i.e. span values)								
Width, in.	Gauge	Yield ksi	Weight psf	Top in Compression			Bottom in Compression			Positive Load								
				I_{xx} in ⁴ /ft	I_{xx} (eff) in ⁴ /ft	S_{xx} in ³ /ft	I_{xx} in ⁴ /ft	I_{xx} (eff) in ⁴ /ft	S_{xx} in ³ /ft	2'	2.5'	3'	3.5'	4'	4.5'	5'	5.5'	6'
36	26	80	1.02	0.0250	0.0250	0.0570	0.0250	0.0250	0.0570	356.3	228.0	158.3	116.3	89.1	70.4	57.0		
36	24	50	1.33	0.0240	0.0240	0.0777	0.0240	0.0240	0.0777	485.6	310.8	215.8	158.6	121.4	95.9	77.7	64.2	54.0
36	22	50	1.73	0.0400	0.0400	0.0914	0.0400	0.0400	0.0914	571.3	365.6	253.9	186.5	142.8	112.8	91.4	75.5	63.5
36	0.032"	19	0.451	0.0450	0.0450	0.1030	0.0450	0.0450	0.1030	244.6	156.6	108.7	79.9	61.2	48.3			

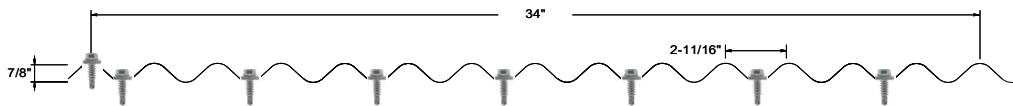

FIGURE 1-5 CLASSIC CORRUGATED PANELS (7 SCREWS)

BR-36

Panel profile and Fastening Schedule

Minimum three (3) No. 12 hex-head screws across the panel width at all supports.

Sidlap fasteners are No. 14 hex head screw, Lap Tek self-drilling screws at 12" OC.

NEGATIVE LOAD

				SECTION PROPERTIES						ALLOWABLE UNIFORM LOADS, psf For various clip spacings (i.e. span values)						
Width, in.	Gauge	Yield ksi	Weight psf	Top in Compression			Bottom in Compression			Negative Load						
				I_{xx} in ⁴ /ft	I_{xx} (eff) in ⁴ /ft	S_{xx} in ³ /ft	I_{xx} in ⁴ /ft	I_{xx} (eff) in ⁴ /ft	S_{xx} in ³ /ft	2'	2.5'	3'	3.5'	4'	4.5'	5'
36	24	50	1.18	0.1170	0.1070	0.1010	0.0840	0.0936	0.1180	137.5	122.1	106.7	91.3	75.8	60.4	45.0
36	22	50	1.46	0.1470	0.1350	0.1300	0.1070	0.1190	0.1480	100.0	90.0	80.0	70.0	60.0	50.0	40.0
36	20	33	1.76	0.1970	0.1830	0.1950	0.1470	0.1620	0.2080	100.0	89.8	79.7	69.5	59.3	49.2	39.0
36	18	33	2.11	0.2600	0.2474	0.2770	0.2167	0.2293	0.3083	100.0	89.8	79.7	69.5	59.3	49.2	39.0
36	0.032"	19	0.52	0.1867	0.1867	0.2000	0.1867	0.1867	0.3250	55.0	51.7	48.3	45.0	41.7	38.3	35.0
36	0.040"	19	0.65	0.2330	0.2330	0.2490	0.2330	0.2330	0.4037	75.0	69.2	63.3	57.5	51.7	45.8	40.0
36	0.050"	19	0.78	0.3093	0.3093	0.5000	0.3093	0.3093	0.4263	75.0	69.2	63.3	57.5	51.7	45.8	40.0

POSITIVE LOAD

				SECTION PROPERTIES						ALLOWABLE UNIFORM LOADS, psf For various clip spacings (i.e. span values)									
Width, in.	Gauge	Yield ksi	Weight psf	Top in Compression			Bottom in Compression			Positive Load									
				I_{xx} in ⁴ /ft	I_{xx} (eff) in ⁴ /ft	S_{xx} in ³ /ft	I_{xx} in ⁴ /ft	I_{xx} (eff) in ⁴ /ft	S_{xx} in ³ /ft	2'	2.5'	3'	3.5'	4'	4.5'	5'	5.5'	6'	8'
36	24	50	1.18	0.1170	0.1070	0.1010	0.0840	0.0936	0.1180	490.0	392.0	280.6	206.1	157.8	124.7	101.0	83.5	70.1	39.5
36	22	50	1.46	0.1470	0.1350	0.1300	0.1070	0.1190	0.1480	676.8	520.0	361.1	265.3	203.1	160.5	130.0	107.4	90.3	50.8
36	20	33	1.76	0.1970	0.1830	0.1950	0.1470	0.1620	0.2080	656.8	514.8	357.5	262.7	201.1	158.9	128.7	106.4	89.4	50.3
36	18	33	2.11	0.2600	0.2474	0.2770	0.2167	0.2293	0.3083	1086.4	731.3	507.8	373.1	285.7	225.7	182.8	151.1	127.0	71.4
36	0.032"	19	0.52	0.1867	0.1867	0.2000	0.1867	0.1867	0.3250	106.7	68.3	47.4	34.8	26.7	21.1	17.1	14.1	11.9	6.7
36	0.040"	19	0.65	0.2330	0.2330	0.2490	0.2330	0.2330	0.4037	128.2	102.6	73.8	54.2	41.5	32.8	26.6	22.0	18.4	10.4
36	0.050"	19	0.78	0.3093	0.3093	0.5000	0.3093	0.3093	0.4263	200.0	160.0	114.4	84.1	64.4	50.9	41.2	34.1	28.6	16.1

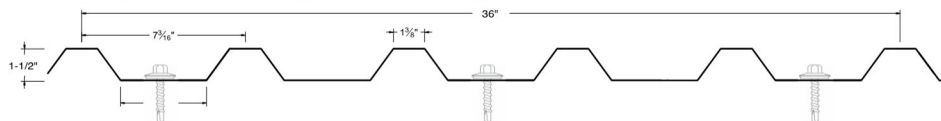

FIGURE 1-6 BR-36 PANELS (3 SCREWS)

BR-36

Panel profile and Fastening Schedule

Minimum five (5) No. 12 hex-head screws across the panel width at all supports. Sidelap fasteners are No. 14 hex head screw, Lap Tek self-drilling screws at 12" OC.

NEGATIVE LOAD

				SECTION PROPERTIES						ALLOWABLE UNIFORM LOADS, psf For various clip spacings (i.e. span values)						
Width, in.	Gauge	Yield ksi	Weight psf	Top in Compression			Bottom in Compression			Negative Load						
				I_{xx} in ⁴ /ft.	I_{xx} (eff) in ⁴ /ft.	S_{xx} in ³ /ft.	I_{xx} in ⁴ /ft.	I_{xx} (eff) in ⁴ /ft.	S_{xx} in ³ /ft.	2'	2.5'	3'	3.5'	4'	4.5'	5'
36	24	50	1.18	0.1170	0.1070	0.1010	0.0840	0.0936	0.1180	200.0	179.2	158.3	137.5	116.7	95.8	75.0
36	22	50	1.46	0.1470	0.1350	0.1300	0.1070	0.1190	0.1480	200.0	180.0	160.0	140.0	120.0	100.0	80.0
36	20	33	1.76	0.1970	0.1830	0.1950	0.1470	0.1620	0.2080	170.0	153.1	136.2	119.3	102.3	85.4	68.5
36	18	33	2.11	0.2600	0.2474	0.2770	0.2167	0.2293	0.3083	170.0	153.1	136.2	119.3	102.3	85.4	68.5
36	0.032"	19	0.52	0.1867	0.1867	0.2000	0.1867	0.1867	0.3250	135.0	122.7	110.3	98.0	85.7	73.3	61.0
36	0.040"	19	0.65	0.2330	0.2330	0.2490	0.2330	0.2330	0.4037	171.0	150.8	130.7	110.5	90.3	70.2	50.0
36	0.050"	19	0.78	0.3093	0.3093	0.5000	0.3093	0.3093	0.4263	171.0	150.8	130.7	110.5	90.3	70.2	50.0

POSITIVE LOAD

				SECTION PROPERTIES						ALLOWABLE UNIFORM LOADS, psf Positive Load									
Width, in.	Gauge	Yield ksi	Weight psf	Top in Compression			Bottom in Compression			Positive Load									
				I_{xx} in ⁴ /ft.	I_{xx} (eff) in ⁴ /ft.	S_{xx} in ³ /ft.	I_{xx} in ⁴ /ft.	I_{xx} (eff) in ⁴ /ft.	S_{xx} in ³ /ft.	2'	2.5'	3'	3.5'	4'	4.5'	5'	5.5'	6'	8'
36	24	50	1.18	0.1170	0.1070	0.1010	0.0840	0.0936	0.1180	490.0	392.0	280.6	206.1	157.8	124.7	101.0	83.5	70.1	39.5
36	22	50	1.46	0.1470	0.1350	0.1300	0.1070	0.1190	0.1480	676.8	520.0	361.1	265.3	203.1	160.5	130.0	107.4	90.3	50.8
36	20	33	1.76	0.1970	0.1830	0.1950	0.1470	0.1620	0.2080	656.8	514.8	357.5	262.7	201.1	158.9	128.7	106.4	89.4	50.3
36	18	33	2.11	0.2600	0.2474	0.2770	0.2167	0.2293	0.3083	1086.4	731.3	507.8	373.1	285.7	225.7	182.8	151.1	127.0	71.4
36	0.032"	19	0.52	0.1867	0.1867	0.2000	0.1867	0.1867	0.3250	106.7	68.3	47.4	34.8	26.7	21.1	17.1	14.1	11.9	6.7
36	0.040"	19	0.65	0.2330	0.2330	0.2490	0.2330	0.2330	0.4037	128.2	102.6	73.8	54.2	41.5	32.8	26.6	22.0	18.4	10.4
36	0.050"	19	0.78	0.3093	0.3093	0.5000	0.3093	0.3093	0.4263	200.0	160.0	114.4	84.1	64.4	50.9	41.2	34.1	28.6	16.1

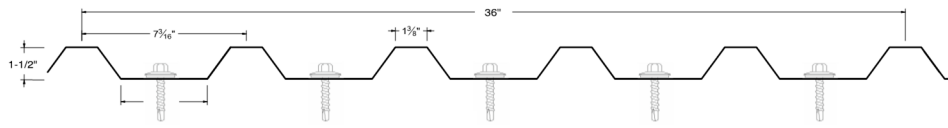

FIGURE 1-7 BR-36 PANELS (5 SCREWS)

Contour C-5 Clip Flange

Panel profile and Fastening Schedule

All panels must be attached to support as described in Section 3.2 of the evaluation report using a minimum of two (2) #10 screws through the 18 ga. Standard Contour Clip. Fasteners must be placed inline with framing (perpendicular to the panel).

NEGATIVE LOAD

				SECTION PROPERTIES						ALLOWABLE UNIFORM LOADS, psf For various clip spacings (i.e. span values)						
Width, in.	Gauge	Yield ksi	Weight psf	Top in Compression			Bottom in Compression			Negative Load						
				I_{xx} in ⁴ /ft.	I_{xx} (eff) in ⁴ /ft.	S_{xx} in ³ /ft.	I_{xx} in ⁴ /ft.	I_{xx} (eff) in ⁴ /ft.	S_{xx} in ³ /ft.	1'	1.5'	2'	2.5'	3'	3.5'	4'
12	24	50	1.89	0.1064	0.1062	0.1362	0.1056	0.1058	0.1513	150.0	136.6	123.3	110.0	96.6	83.3	70.0
12	22	50	2.21	0.1323	0.1321	0.1766	0.1316	0.1318	0.1986	219.0	194.1	169.3	144.5	119.6	94.8	70.0
12	20	33	2.69	0.1804	0.1800	0.2562	0.1790	0.1794	0.2938	219.0	194.1	169.3	144.5	119.6	94.8	70.0
12	18	33	3.48	0.2460	0.2450	0.3635	0.2410	0.2420	0.4126	219.0	194.1	169.3	144.5	119.6	94.8	70.0
12	0.032"	19	0.52	0.1802	0.1802	0.2665	0.1802	0.1802	0.3148	110.0	101.6	93.3	85.0	76.6	68.3	60.0
12	0.040"	19	1.14	0.2210	0.2210	0.3270	0.2210	0.2210	0.3860	110.0	101.6	93.3	85.0	76.6	68.3	60.0

POSITIVE LOAD

				SECTION PROPERTIES						ALLOWABLE UNIFORM LOADS, psf For various clip spacings (i.e. span values)									
Width, in.	Gauge	Yield ksi	Weight psf	Top in Compression			Bottom in Compression			Positive Load									
				I_{xx} in ⁴ /ft.	I_{xx} (eff) in ⁴ /ft.	S_{xx} in ³ /ft.	I_{xx} in ⁴ /ft.	I_{xx} (eff) in ⁴ /ft.	S_{xx} in ³ /ft.	1'	2'	3'	4'	5'	6'	7'	8'	9'	10'
12	24	50	1.89	0.1064	0.1062	0.1362	0.1056	0.1058	0.1513	1776.4	851.3	378.3	212.8	136.2	94.6	69.5	53.2	42.0	34.1
12	22	50	2.21	0.1323	0.1321	0.1766	0.1316	0.1318	0.1986	1904.6	952.27	490.56	275.94	176.6	122.64	90.1	68.98	54.5	44.2
12	20	33	2.69	0.1804	0.1800	0.2562	0.1790	0.1794	0.2938	1916.4	958.18	474.44	266.9	170.8	118.6	87.14	66.7	52.7	42.7
12	18	33	3.48	0.2460	0.2450	0.3635	0.2410	0.2420	0.4126	3306.4	1514.6	673.2	378.65	242.33	168.29	123.64	94.66	74.8	60.6
12	0.032"	19	0.52	0.1802	0.1802	0.2665	0.1802	0.1802	0.3148	248.2	124.1	82.7	62.1	49.6	34.8	25.56	19.57	15.5	12.5
12	0.040"	19	1.14	0.2210	0.2210	0.3270	0.2210	0.2210	0.3860	380.9	190.5	127.0	95.2	73.6	51.1	37.54	28.74	22.7	18.4

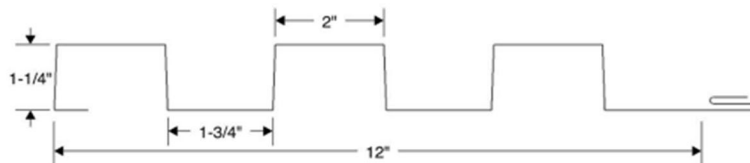

FIGURE 1-8 CONTOUR C-5 CLIP FLANGE PANELS

Contour C-5 Screw Flange

Panel profile and Fastening Schedule

All panels must be attached to support as described in Section 3.2 of the evaluation report using minimum two (2) 1-1/2" x #10 screws through the integrated panel screw flange. Fasteners were placed inline with the framing (perpendicular with the panel).

NEGATIVE LOAD

				SECTION PROPERTIES						ALLOWABLE UNIFORM LOADS, psf For various clip spacings (i.e. span values)						
Width, in.	Gauge	Yield ksi	Weight psf	Top in Compression			Bottom in Compression			Negative Load						
				I_{xx} in ⁴ /ft.	$I_{xx(eff)}$ in ⁴ /ft.	S_{xx} in ³ /ft.	I_{xx} in ⁴ /ft.	$I_{xx(eff)}$ in ⁴ /ft.	S_{xx} in ³ /ft.	1'	1.5'	2'	2.5'	3'	3.5'	4'
12	24	50	1.89	0.1137	0.1153	0.1382	0.1191	0.1175	0.1804	177.5	161.2	145.0	128.7	112.5	96.2	80.0
12	22	50	2.21	0.1361	0.1370	0.1757	0.1391	0.1382	0.2805	190.0	176.6	163.3	150.0	136.6	123.3	110.0
12	20	33	2.69	0.1860	0.1868	0.2545	0.1890	0.1881	0.2790	190.0	176.6	163.3	150.0	136.6	123.3	110.0
12	18	33	3.48	0.2550	0.2598	0.3610	0.2510	0.2522	0.3600	190.0	176.6	163.3	150.0	136.6	123.3	110.0
12	0.032"	19	0.52	0.1860	0.2642	0.3492	0.1860	0.1860	0.3414	140.0	122.5	105.0	87.5	70.0	52.5	35.0
12	0.040"	19	1.14	0.2290	0.2290	0.3246	0.2290	0.2290	0.4206	140.0	122.5	105.0	87.5	70.0	52.5	35.0

POSITIVE LOAD

				SECTION PROPERTIES						ALLOWABLE UNIFORM LOADS, psf For various clip spacings (i.e. span values)									
Width, in.	Gauge	Yield ksi	Weight psf	Top in Compression			Bottom in Compression			Positive Load									
				I_{xx} in ⁴ /ft.	$I_{xx(eff)}$ in ⁴ /ft.	S_{xx} in ³ /ft.	I_{xx} in ⁴ /ft.	$I_{xx(eff)}$ in ⁴ /ft.	S_{xx} in ³ /ft.	1'	2'	3'	4'	5'	6'	7'	8'	9'	10'
12	24	50	1.89	0.1137	0.1153	0.1382	0.1191	0.1175	0.1804	1776.4	863.8	383.9	215.6	138.2	96.0	70.5	54.0	42.7	34.6
12	22	50	2.21	0.1361	0.1370	0.1757	0.1391	0.1382	0.2805	1904.6	952.3	488.1	274.5	175.7	122.0	89.6	68.6	54.2	43.9
12	20	33	2.69	0.1860	0.1868	0.2545	0.1890	0.1881	0.2790	1916.4	958.2	471.3	265.1	169.7	117.8	86.6	66.3	52.4	42.4
12	18	33	3.48	0.2550	0.2598	0.3610	0.2510	0.2522	0.3600	3306.4	1500.0	666.7	375.0	240.0	166.7	122.5	93.8	74.1	60.0
12	0.032"	19	0.52	0.1860	0.2642	0.3492	0.1860	0.1860	0.3414	248.2	124.1	82.7	62.1	49.6	34.5	25.3	19.4	15.3	12.4
12	0.040"	19	1.14	0.2290	0.2290	0.3246	0.2290	0.2290	0.4206	380.9	190.5	127.0	95.2	73.0	50.7	37.3	28.5	22.5	18.3

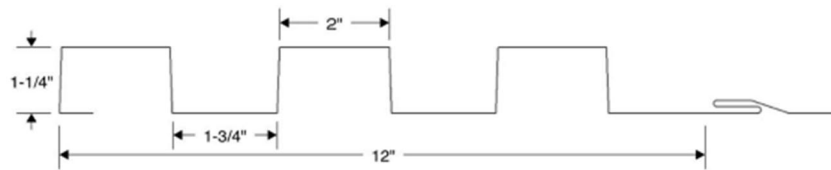

FIGURE 1-9 CONTOUR C-5 SCREW FLANGE PANELS

Contour C-7/CR-A Clip Flange

Panel profile and Fastening Schedule

All panels must be attached to support as described in Section 3.2 of the evaluation report using a minimum of two (2) #10 screws through the 18 ga. Standard Contour Clip. Fasteners must be placed inline with framing (perpendicular to the panel).

NEGATIVE LOAD

				SECTION PROPERTIES						ALLOWABLE UNIFORM LOADS, psf For various clip spacings (i.e. span values)						
Width, in.	Gauge	Yield ksi	Weight psf	Top in Compression			Bottom in Compression			Negative Load						
				I_{xx} in ⁴ /ft.	$I_{xx(eff)}$ in ⁴ /ft.	S_{xx} in ³ /ft.	I_{xx} in ⁴ /ft.	$I_{xx(eff)}$ in ⁴ /ft.	S_{xx} in ³ /ft.	1'	1.5'	2'	2.5'	3'	3.5'	4'
12	24	50	1.39	0.0516	0.0573	0.0523	0.0712	0.0655	0.0875	212.5	186.3	160.0	133.8	107.5	81.3	55.0
12	22	50	1.65	0.0657	0.0722	0.0675	0.0882	0.0817	0.1110	187.5	167.9	148.3	128.8	109.2	89.6	70.0
12	20	33	2.01	0.0876	0.0952	0.0921	0.1137	0.1060	0.1472	187.5	167.9	148.3	128.8	109.2	89.6	70.0
12	18	33	2.60	0.1280	0.1367	0.1398	0.1580	0.1493	0.2143	187.5	167.9	148.3	128.8	109.2	89.6	70.0
12	0.032"	19	0.52	0.1720	0.1720	0.2421	0.1720	0.1720	0.3205	137.5	124.6	111.7	98.8	85.8	72.9	60.0
12	0.040"	19	1.14	0.2130	0.2130	0.3954	0.2130	0.2130	0.3440	137.5	124.6	111.7	98.8	85.8	72.9	60.0

POSITIVE LOAD

				SECTION PROPERTIES						ALLOWABLE UNIFORM LOADS, psf For various clip spacings (i.e. span values)									
Width, in.	Gauge	Yield ksi	Weight psf	Top in Compression			Bottom in Compression			Positive Load									
				I_{xx} in ⁴ /ft.	$I_{xx(eff)}$ in ⁴ /ft.	S_{xx} in ³ /ft.	I_{xx} in ⁴ /ft.	$I_{xx(eff)}$ in ⁴ /ft.	S_{xx} in ³ /ft.	1'	2'	3'	4'	5'	6'	7'	8'	9'	10'
12	24	50	1.39	0.0516	0.0573	0.0523	0.0712	0.0655	0.0875	354.6	177.3	118.2	81.7	52.3	36.3	26.7	20.4	16.1	13.1
12	22	50	1.65	0.0657	0.0722	0.0675	0.0882	0.0817	0.1110	488.2	244.09	162.73	105.47	67.5	46.88	34.44	26.37	20.8	16.9
12	20	33	2.01	0.0876	0.0952	0.0921	0.1137	0.1060	0.1472	470.9	235.45	156.97	95.9	61.4	42.6	31.33	24.0	19.0	15.4
12	18	33	2.60	0.1280	0.1367	0.1398	0.1580	0.1493	0.2143	675.45	337.73	225.2	145.62	93.2	64.72	47.55	36.41	28.8	23.3
12	0.032"	19	0.52	0.1720	0.1720	0.2421	0.1720	0.1720	0.3205	54.6	27.3	18.2	13.6	10.9					
12	0.040"	19	1.14	0.2130	0.2130	0.3954	0.2130	0.2130	0.3440	86.4	43.2	28.8	21.6	17.3	14.4	11.35			

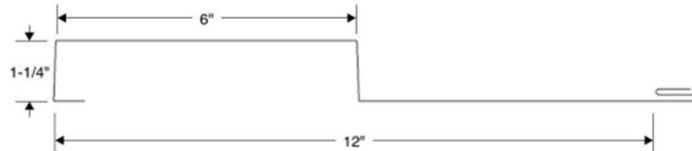

FIGURE 1-10 CONTOUR C-7/CR-A CLIP FLANGE PANELS

Contour C-8 Clip Flange

Panel profile and Fastening Schedule

All panels must be attached to support as described in Section 3.2 of the evaluation report using a minimum of two (2) #10 screws through the 18 ga. Standard Contour Clip. Fasteners must be placed inline with framing (perpendicular to the panel).

NEGATIVE LOAD

				SECTION PROPERTIES						ALLOWABLE UNIFORM LOADS, psf For various clip spacings (i.e. span values)							
Width, in.	Gauge	Yield ksi	Weight psf	Top in Compression			Bottom in Compression			Negative Load							
				I_{xx} in ⁴ /ft.	I_{xx} (eff) in ⁴ /ft.	S_{xx} in ³ /ft.	I_{xx} in ⁴ /ft.	I_{xx} (eff) in ⁴ /ft.	S_{xx} in ³ /ft.	1'	1.5'	2'	2.5'	3'	3.5'	4'	
12	24	50	1.39	0.0770	0.0845	0.0952	0.1031	0.0955	0.1307	162.5	145.8	129.2	112.5	95.8	79.2	62.5	
12	22	50	1.65	0.0967	0.1056	0.1229	0.1275	0.1185	0.1653	212.5	187.5	162.5	137.5	112.5	87.5	62.5	
12	20	33	2.01	0.1268	0.1374	0.1670	0.1636	0.1529	0.2183	212.5	187.5	162.5	137.5	112.5	87.5	62.5	
12	18	33	2.60	0.1960	0.2070	0.2845	0.2370	0.2250	0.3393	212.5	187.5	162.5	137.5	112.5	87.5	62.5	
12	0.032"	19	0.52	0.1820	0.1820	0.3169	0.1820	0.1820	0.2686	125.0	115.8	106.7	97.5	88.3	79.2	70.0	
12	0.040"	19	1.14	0.2240	0.2240	0.3907	0.2240	0.2240	0.3947	125.0	115.8	106.7	97.5	88.3	79.2	70.0	

POSITIVE LOAD

				SECTION PROPERTIES						ALLOWABLE UNIFORM LOADS, psf For various clip spacings (i.e. span values)									
Width, in.	Gauge	Yield ksi	Weight psf	Top in Compression			Bottom in Compression			Positive Load									
				I_{xx}	I_{xx} (eff)	S_{xx}	I_{xx}	I_{xx} (eff)	S_{xx}	1'	2'	3'	4'	5'	6'	7'	8'	9'	10'
12	24	50	1.39	0.0770	0.0845	0.0952	0.1031	0.0955	0.1307	1064.6	532.3	264.4	148.8	95.2	66.1	48.6	37.2	29.4	23.8
12	22	50	1.65	0.0967	0.1056	0.1229	0.1275	0.1185	0.1653	1465.5	732.73	341.39	192.0	122.9	85.35	62.7	48.0	37.9	30.7
12	20	33	2.01	0.1268	0.1374	0.1670	0.1636	0.1529	0.2183	1410.9	695.83	309.26	174.0	111.3	77.3	56.8	43.5	34.4	27.8
12	18	33	2.60	0.1960	0.2070	0.2845	0.2370	0.2250	0.3393	2024.6	1012.3	526.9	296.35	189.67	131.71	96.77	74.09	58.5	47.4
12	0.032"	19	0.52	0.1820	0.1820	0.3169	0.1820	0.1820	0.2686	161.8	80.9	53.9	40.5	32.4	27.0	23.12	20.23	18.0	14.8
12	0.040"	19	1.14	0.2240	0.2240	0.3907	0.2240	0.2240	0.3947	258.2	129.1	56.1	64.6	51.6	43.0	36.33	32.27	27.1	21.9

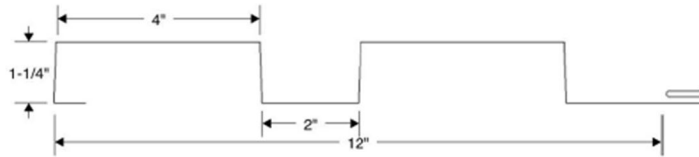

FIGURE 1-11 CONTOUR C-8 CLIP FLANGE PANELS

Contour C-1/CE-A Clip Flange

Contour C-1/CE-A Clip Flange
Panel profile and Fastening Schedule

All panels must be attached to support as described in Section 3.2 of the evaluation report using a minimum of two (2) #10 screws through the 18 ga. Standard Contour Clip. Fasteners must be placed inline with framing (perpendicular to the panel).

NEGATIVE LOAD

				SECTION PROPERTIES						ALLOWABLE UNIFORM LOADS, psf For various clip spacings (i.e. span values)						
Width, in.	Gauge	Yield ksi	Weight psf	Top in Compression			Bottom in Compression			Negative Load						
				I_{xx} in ⁴ /ft.	I_{xx} (eff) in ⁴ /ft.	S_{xx} in ³ /ft	I_{xx} in ⁴ /ft.	I_{xx} (eff) in ⁴ /ft.	S_{xx} in ³ /ft	1'	1.5'	2'	2.5'	3'	3.5'	4'
16	24	50	1.67	0.0323	0.0329	0.0692	0.0345	0.0338	0.0731	95.0	87.5	80.0	72.5	65.0	57.5	50.0
16	22	50	1.96	0.0398	0.0406	0.0898	0.0428	0.0419	0.0938	87.5	82.9	78.3	73.8	69.2	64.6	60.0
16	20	33	2.4	0.0541	0.0541	0.1300	0.0541	0.0541	0.1230	87.5	82.9	78.3	73.8	69.2	64.6	60.0
16	18	33	3.11	0.0706	0.0706	0.1710	0.0706	0.0706	0.1662	87.5	82.9	78.3	73.8	69.2	64.6	60.0
16	0.032"	19	0.69	0.0511	0.0511	0.1231	0.0511	0.0511	0.1177	70.0	63.3	56.7	50.0	43.3	36.7	30.0
16	0.040"	19	1.52	0.0631	0.0631	0.1528	0.0631	0.0631	0.1477	70.0	63.3	56.7	50.0	43.3	36.7	30.0

POSITIVE LOAD

				SECTION PROPERTIES						ALLOWABLE UNIFORM LOADS, psf For various clip spacings (i.e. span values)									
Width, in.	Gauge	Yield ksi	Weight psf	Top in Compression			Bottom in Compression			Positive Load									
				I_{xx} in ⁴ /ft.	I_{xx} (eff) in ⁴ /ft.	S_{xx} in ³ /ft	I_{xx} in ⁴ /ft.	I_{xx} (eff) in ⁴ /ft.	S_{xx} in ³ /ft	1'	2'	3'	4'	5'	6'	7'	8'	9'	10'
16	24	50	1.67	0.0323	0.0329	0.0692	0.0345	0.0338	0.0731	1473.6	432.5	192.2	108.1	69.2	48.1	35.3	27.0	21.4	17.3
16	22	50	1.96	0.0398	0.0406	0.0898	0.0428	0.0419	0.0938	932.7	466.36	249.44	140.3	89.8	62.4	45.82	35.1	27.7	21.4
16	20	33	2.4	0.0541	0.0541	0.1300	0.0541	0.0541	0.1230	1586.4	512.5	227.78	128.1	82.0	56.9	41.94	32.0	25.3	20.5
16	18	33	3.11	0.0706	0.0706	0.1710	0.0706	0.0706	0.1662	2733.6	692.5	307.8	173.12	110.8	76.94	56.53	43.28	34.2	27.7
16	0.032"	19	0.69	0.0511	0.0511	0.1231	0.0511	0.0511	0.1177	228.2	114.1	76.1	49.8	31.9	22.2	16.27	12.46		
16	0.040"	19	1.52	0.0631	0.0631	0.1528	0.0631	0.0631	0.1477	357.3	178.6	119.1	67.5	43.2	30.0	22.05	16.89	13.3	10.8

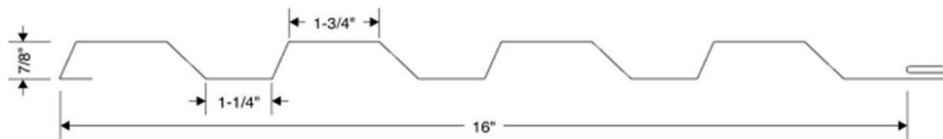

FIGURE 1-12 CONTOUR C-1/CE-A CLIP FLANGE PANELS

Contour C-1/CE-A Screw Flange

Panel profile and Fastening Schedule

All panels were attached to support as described in Section 3.2 using a minimum of two (2) 1-1/2" x #10 screws through the integrated panel screw flange. Fasteners were placed inline with the framing (perpendicular with the panel).

NEGATIVE LOAD

				SECTION PROPERTIES						ALLOWABLE UNIFORM LOADS, psf For various fastener spacings (i.e. span values)						
Width, in.	Gauge	Yield ksi	Weight psf	Top in Compression			Bottom in Compression			Negative Load						
				I_{xx} in ⁴ /ft.	I_{xx} (eff) in ⁴ /ft.	S_{xx} in ³ /ft.	I_{xx} in ⁴ /ft.	I_{xx} (eff) in ⁴ /ft.	S_{xx} in ³ /ft.	1'	1.5'	2'	2.5'	3'	3.5'	4'
16	24	50	1.67	0.0345	0.0431	0.0706	0.0361	0.0389	0.0797	100.0	92.5	85.0	77.5	70.0	62.5	55.0
16	22	50	1.96	0.0421	0.0427	0.0912	0.0444	0.0437	0.1000	200.0	179.2	158.3	137.5	116.7	95.8	75.0
16	20	33	2.4	0.0570	0.0567	0.1312	0.0560	0.0563	0.1325	200.0	179.2	158.3	137.5	116.7	95.8	75.0
16	18	33	3.11	0.0750	0.0747	0.1735	0.0740	0.0743	0.1811	200.0	179.2	158.3	137.5	116.7	95.8	75.0
16	0.032"	19	0.69	0.0534	0.0534	0.1246	0.0543	0.0543	0.1274	65.0	59.2	53.3	47.5	41.7	35.8	30.0
16	0.040"	19	1.52	0.0669	0.0669	0.1546	0.0669	0.0669	0.1616	65.0	59.2	53.3	47.5	41.7	35.8	30.0

POSITIVE LOAD

				SECTION PROPERTIES						ALLOWABLE UNIFORM LOADS, psf For various fastener spacings (i.e. span values)									
Width, in.	Gauge	Yield ksi	Weight psf	Top in Compression			Bottom in Compression			Positive Load									
				I_{xx} in ⁴ /ft.	I_{xx} (eff) in ⁴ /ft.	S_{xx} in ³ /ft.	I_{xx} in ⁴ /ft.	I_{xx} (eff) in ⁴ /ft.	S_{xx} in ³ /ft.	1'	2'	3'	4'	5'	6'	7'	8'	9'	10'
16	24	50	1.67	0.0345	0.0431	0.0706	0.0361	0.0389	0.0797	1473.6	441.3	196.1	110.3	70.6	49.0	36.0	27.6	21.8	17.7
16	22	50	1.96	0.0421	0.0427	0.0912	0.0444	0.0437	0.1000	932.7	466.36	253.33	142.5	91.2	63.33	46.53	35.6	28.2	22.5
16	20	33	2.4	0.0570	0.0567	0.1312	0.0560	0.0563	0.1325	1586.4	546.67	242.96	136.7	87.5	60.7	44.63	34.2	27.0	21.9
16	18	33	3.11	0.0750	0.0747	0.1735	0.0740	0.0743	0.1811	2733.6	722.9	321.3	180.73	115.67	80.32	59.01	45.18	35.7	28.9
16	0.032"	19	0.69	0.0534	0.0534	0.1246	0.0543	0.0543	0.1274	228.2	114.1	76.1	52.8	33.8	23.5	17.23	13.19	10.4	
16	0.040"	19	1.52	0.0669	0.0669	0.1546	0.0669	0.0669	0.1616	357.3	178.6	119.1	70.7	45.3	31.4	23.08	17.67	14.0	11.3



FIGURE 1-13 CONTOUR C1/CE-A SCREW FLANGE PANELS

Contour C-B (CE-B) Clip Flange

Panel profile and Fastening Schedule

All panels must be attached to support as described in Section 3.2 of the evaluation report using a minimum of two (2) #10 screws through the 18 ga. Standard Contour Clip. Fasteners must be placed inline with framing (perpendicular to the panel).

NEGATIVE LOAD

				SECTION PROPERTIES						ALLOWABLE UNIFORM LOADS, psf For various clip spacings (i.e. span values)						
Width, in.	Gauge	Yield ksi	Weight psf	Top in Compression			Bottom in Compression			Negative Load						
				I_{xx} in ⁴ /ft.	I_{xx} (eff) in ⁴ /ft.	S_{xx} in ³ /ft.	I_{xx} in ⁴ /ft.	I_{xx} (eff) in ⁴ /ft.	S_{xx} in ³ /ft.	1'	1.5'	2'	2.5'	3'	3.5'	4'
16	24	50	1.70	0.0323	0.0349	0.0625	0.0413	0.0387	0.0718	137.5	125.0	112.5	100.0	87.5	75.0	62.5
16	22	50	2.00	0.0406	0.0438	0.0818	0.0518	0.0485	0.0926	175.0	157.8	140.6	123.4	106.3	89.1	71.9
16	20	33	3.44	0.0560	0.0592	0.1211	0.0670	0.0638	0.1238	175.0	157.8	140.6	123.4	106.3	89.1	71.9
16	18	33	3.18	0.0782	0.0819	0.1590	0.0909	0.0872	0.1665	175.0	157.8	140.6	123.4	106.3	89.1	71.9

POSITIVE LOAD

				SECTION PROPERTIES						ALLOWABLE UNIFORM LOADS, psf For various clip spacings (i.e. span values)									
Width, in.	Gauge	Yield ksi	Weight psf	Top in Compression			Bottom in Compression			Positive Load									
				I_{xx} in ⁴ /ft.	I_{xx} (eff) in ⁴ /ft.	S_{xx} in ³ /ft.	I_{xx} in ⁴ /ft.	I_{xx} (eff) in ⁴ /ft.	S_{xx} in ³ /ft.	1'	2'	3'	4'	5'	6'	7'	8'	9'	10'
16	24	50	1.70	0.0323	0.0349	0.0625	0.0413	0.0387	0.0718	980.0	390.6	173.6	97.7	62.5	43.4	31.9	24.4	19.3	15.6
16	22	50	2.00	0.0406	0.0438	0.0818	0.0518	0.0485	0.0926	1049.1	511.3	227.2	127.8	81.8	56.8	41.7	32.0	25.3	20.5
16	20	33	3.44	0.0560	0.0592	0.1211	0.0670	0.0638	0.1238	1054.6	504.6	224.3	126.2	80.7	56.1	41.2	31.5	24.9	20.2
16	18	33	3.18	0.0782	0.0819	0.1590	0.0909	0.0872	0.1665	1817.3	662.5	294.4	165.6	106.0	73.6	54.1	41.4	32.7	26.5
16	0.032"	19	0.72	0.0647	0.0647	0.1640	0.0647	0.0647	0.1200	151.8	75.9	50.6	38.0	30.4	22.6	16.6	12.7	10.0	
16	0.040"	19	1.48	0.0804	0.0804	0.2031	0.0804	0.0804	0.1486	238.2	119.1	73.4	59.6	43.3	30.1	22.1	16.9	13.4	10.8

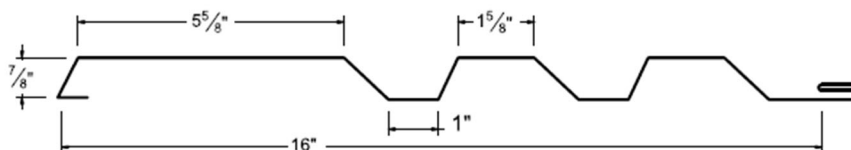

FIGURE 1-14 CONTOUR C-B(CE-B) CLIP FLANGE PANELS

Contour C-C (CE-C) Clip Flange
 Panel profile and Fastening Schedule

All panels must be attached to support as described in Section 3.2 of the evaluation report using a minimum of two (2) #10 screws through the 18 ga. Standard Contour Clip. Fasteners must be placed inline with framing (perpendicular to the panel).

NEGATIVE LOAD

				SECTION PROPERTIES						ALLOWABLE UNIFORM LOADS, psf For various clip spacings (i.e. span values)									
Width, in.	Gauge	Yield ksi	Weight psf	Top in Compression			Bottom in Compression			Negative Load									
				I_{xx} in ⁴ /ft.	$I_{xx} (eff)$ in ⁴ /ft.	S_{xx} in ³ /ft.	I_{xx} in ⁴ /ft.	$I_{xx} (eff)$ in ⁴ /ft.	S_{xx} in ³ /ft.	1'	1.5'	2'	2.5'	3'	3.5'	4'	4.5'	5'	
16	24	50	1.63	0.0233	0.0270	0.0449	0.0361	0.0324	0.0560	150.0	135.9	121.9	107.8	93.7	79.7	65.6	51.5	37.5	
16	22	50	1.91	0.0293	0.0341	0.0589	0.0459	0.0407	0.0724	125.0	114.1	103.1	92.2	81.3	70.3	59.3	48.4	37.5	
16	20	33	2.33	0.0413	0.0472	0.0888	0.0616	0.0557	0.0988	125.0	114.1	103.1	92.2	81.3	70.3	59.3	48.4	37.5	
16	18	33	3.04	0.0571	0.0645	0.1211	0.0827	0.0752	0.1338	125.0	114.1	103.1	92.2	81.3	70.3	59.3	48.4	37.5	

POSITIVE LOAD

				SECTION PROPERTIES						ALLOWABLE UNIFORM LOADS, psf For various clip spacings (i.e. span values)										
Width, in.	Gauge	Yield ksi	Weight psf	Top in Compression			Bottom in Compression			Positive Load										
				I_{xx} in ⁴ /ft.	$I_{xx} (eff)$ in ⁴ /ft.	S_{xx} in ³ /ft.	I_{xx} in ⁴ /ft.	$I_{xx} (eff)$ in ⁴ /ft.	S_{xx} in ³ /ft.	1'	2'	3'	4'	5'	6'	7'	8'	9'	10'	
16	24	50	1.63	0.0233	0.0270	0.0449	0.0361	0.0324	0.0560	490.0	245.0	124.2	69.8	44.7	31.0	22.8	17.5	13.8	11.2	
16	22	50	1.91	0.0293	0.0341	0.0589	0.0459	0.0407	0.0724	524.6	262.3	163.6	92.0	58.9	40.9	30.1	23.0	18.2	14.7	
16	20	33	2.33	0.0413	0.0472	0.0888	0.0616	0.0557	0.0988	527.3	263.6	164.4	92.5	59.2	41.1	30.2	23.1	18.3	14.8	
16	18	33	3.04	0.0571	0.0645	0.1211	0.0827	0.0752	0.1338	909.1	454.6	224.3	126.2	80.7	56.1	41.2	31.5	24.9	20.2	

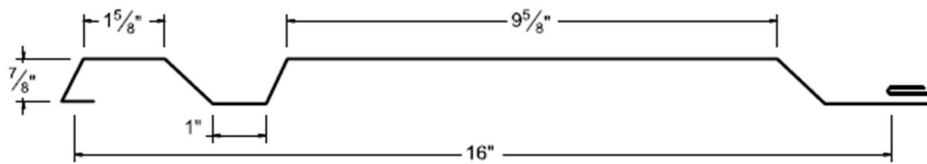

FIGURE 1-15 CONTOUR C-C (CE-C) CLIP FLANGE PANELS

Contour C-D (CE-D) Clip Flange

Contour C-D (CE-D) Clip Flange
Panel profile and Fastening Schedule

All panels must be attached to support as described in Section 3.2 of the evaluation report using a minimum of two (2) #10 screws through the 18 ga. Standard Contour Clip. Fasteners must be placed inline with framing (perpendicular to the panel).

NEGATIVE LOAD

Width, in.	Gauge	Yield ksi	Weight psf	SECTION PROPERTIES									ALLOWABLE UNIFORM LOADS, psf For various clip spacings (i.e. span values)								
				Top in Compression			Bottom in Compression			Negative Load											
				I_{xx} in ⁴ /ft.	I_{xx} (eff) in ⁴ /ft.	S_{xx} in ³ /ft.	I_{xx} in ⁴ /ft.	I_{xx} (eff) in ⁴ /ft.	S_{xx} in ³ /ft.	1'	1.5'	2'	2.5'	3'	3.5'	4'	4.5'	5'			
12	24	50	1.40	0.0177	0.0218	0.0320	0.0318	0.0241	0.0455	197.5	126.6	115.6	104.7	93.8	82.8	71.9	60.9	50.0			
12	22	50	1.65	0.0255	0.0279	0.0425	0.0410	0.0356	0.0598	175.0	157.8	140.6	123.4	106.3	89.1	71.9	54.7	37.5			
12	20	33	2.01	0.0326	0.0399	0.0669	0.0576	0.0504	0.0871	175.0	157.8	140.6	123.4	106.3	89.1	71.9	54.7	37.5			
12	18	33	2.60	0.0470	0.0563	0.1033	0.0790	0.0697	0.1206	175.0	157.8	140.6	123.4	106.3	89.1	71.9	54.7	37.5			

POSITIVE LOAD

Width, in.	Gauge	Yield ksi	Weight psf	SECTION PROPERTIES									ALLOWABLE UNIFORM LOADS, psf For various clip spacings (i.e. span values)									
				Top in Compression			Bottom in Compression			Positive Load												
				I_{xx} in ⁴ /ft.	I_{xx} (eff) in ⁴ /ft.	S_{xx} in ³ /ft.	I_{xx} in ⁴ /ft.	I_{xx} (eff) in ⁴ /ft.	S_{xx} in ³ /ft.	1'	2'	3'	4'	5'	6'	7'	8'	9'	10'			
12	24	50	1.40	0.0177	0.0218	0.0320	0.0318	0.0241	0.0455	245.45	122.7	81.8	61.6	45.5	31.6	23.2	17.8	14.1	11.4			
12	22	50	1.65	0.0255	0.0279	0.0425	0.0410	0.0356	0.0598	262.7	131.4	87.6	65.7	52.6	41.5	30.5	23.4	18.5	14.7			
12	20	33	2.01	0.0326	0.0399	0.0669	0.0576	0.0504	0.0871	263.6	131.8	87.9	65.9	52.7	40.3	29.6	22.7	17.9	14.5			
12	18	33	2.60	0.0470	0.0563	0.1033	0.0790	0.0697	0.1206	454.6	227.3	151.5	113.6	80.4	55.8	41.0	31.4	24.8	20.1			

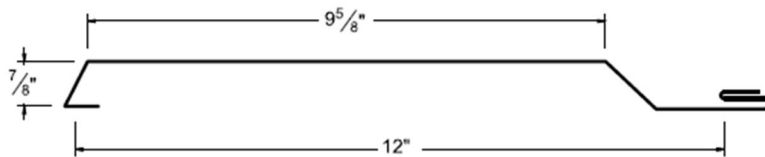

FIGURE 1-16 CONTOUR C-D (CE-D) CLIP FLANGE PANELS

Contour C-E (CE-E) Clip Flange

Panel profile and Fastening Schedule

All panels must be attached to support as described in Section 3.2 of the evaluation report using a minimum of two (2) #10 screws through the 18 ga. Standard Contour Clip. Fasteners must be placed inline with framing (perpendicular to the panel).

NEGATIVE LOAD

Width, in.	Gauge	Yield ksi	Weight psf	SECTION PROPERTIES									ALLOWABLE UNIFORM LOADS, psf For various clip spacings (i.e. span values)								
				Top in Compression			Bottom in Compression			Negative Load											
				I_{xx} in ⁴ /ft.	I_{xx} (eff) in ⁴ /ft.	S_{xx} in ³ /ft.	I_{xx} in ⁴ /ft.	I_{xx} (eff) in ⁴ /ft.	S_{xx} in ³ /ft.	1'	1.5'	2'	2.5'	3'	3.5'	4'	4.5'	5'			
8	24	50	0.90	0.0267	0.0309	0.0476	0.0412	0.0370	0.0622	175.0	160.9	146.9	132.8	118.8	104.7	90.6	76.5	62.5			
8	22	50	1.05	0.0336	0.0392	0.0629	0.0528	0.0472	0.0869	162.5	150.0	137.5	125.0	112.5	100.0	87.5	75.0	62.5			
8	20	33	1.28	0.0483	0.0555	0.0979	0.0730	0.0658	0.1263	162.5	150.0	137.5	125.0	112.5	100.0	87.5	75.0	62.5			
8	18	33	1.66	0.0694	0.0779	0.1496	0.0988	0.0902	0.1736	162.5	150.0	137.5	125.0	112.5	100.0	87.5	75.0	62.5			

POSITIVE LOAD

Width, in.	Gauge	Yield ksi	Weight psf	SECTION PROPERTIES									ALLOWABLE UNIFORM LOADS, psf For various clip spacings (i.e. span values)									
				Top in Compression			Bottom in Compression			Positive Load												
				I_{xx} in ⁴ /ft.	I_{xx} (eff) in ⁴ /ft.	S_{xx} in ³ /ft.	I_{xx} in ⁴ /ft.	I_{xx} (eff) in ⁴ /ft.	S_{xx} in ³ /ft.	1'	2'	3'	4'	5'	6'	7'	8'	9'	10'			
8	24	50	0.90	0.0267	0.0309	0.0476	0.0412	0.0370	0.0622	244.55	122.3	81.5	61.1	47.6	33.1	24.3	18.6	14.7	11.9			
8	22	50	1.05	0.0336	0.0392	0.0629	0.0528	0.0472	0.0869	262.7	131.4	87.6	65.7	52.6	43.7	32.1	24.6	19.4	15.7			
8	20	33	1.28	0.0483	0.0555	0.0979	0.0730	0.0658	0.1263	263.6	131.8	87.9	65.9	52.7	43.9	33.3	25.5	20.1	16.3			
8	18	33	1.66	0.0694	0.0779	0.1496	0.0988	0.0902	0.1736	454.6	227.3	151.5	113.6	80.9	69.3	50.9	39.0	30.8	24.9			

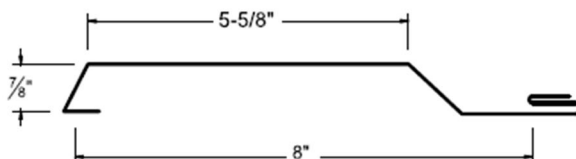

FIGURE 1-17 C-E (CE-E) CLIP FLANGE PANELS

Contour C1-A Clip Flange

Contour C1-A Clip Flange
Panel profile and Fastening Schedule

All panels must be attached to support as described in Section 3.2 of the evaluation report using a minimum of two (2) #10 screws through the 18 ga. Standard Contour Clip. Fasteners must be placed inline with framing (perpendicular to the panel).

NEGATIVE LOAD

				SECTION PROPERTIES									ALLOWABLE UNIFORM LOADS, psf For various clip spacings (i.e. span values)									
Width, in.	Gauge	Yield ksi	Weight psf	Top in Compression			Bottom in Compression			Negative Load												
				I_{xx} in ⁴ /ft.	I_{xx} (eff) in ⁴ /ft.	S_{xx} in ³ /ft.	I_{xx} in ⁴ /ft.	I_{xx} (eff) in ⁴ /ft.	S_{xx} in ³ /ft.	1'	1.5'	2'	2.5'	3'	3.5'	4'	4.5'	5'				
16	24	50	1.67	0.0376	0.0363	0.0628	0.0331	0.0344	0.0674	182.5	165.9	149.4	132.8	116.3	99.7	83.1	66.6	50.0				
16	22	50	1.96	0.0481	0.0463	0.0816	0.0421	0.0438	0.0889	165.0	150.6	136.3	121.9	107.5	93.1	78.8	64.37	50.0				
16	20	33	2.4	0.0661	0.0641	0.1176	0.0594	0.0613	0.1382	165.0	150.6	136.3	121.9	107.5	93.1	78.8	64.37	50.0				
16	18	33	3.11	0.0872	0.0861	0.1570	0.0834	0.0845	0.2039	165.0	150.6	136.3	121.9	107.5	93.1	78.8	64.37	50.0				

POSITIVE LOAD

				SECTION PROPERTIES									ALLOWABLE UNIFORM LOADS, psf For various clip spacings (i.e. span values)										
Width, in.	Gauge	Yield ksi	Weight psf	Top in Compression			Bottom in Compression			Positive Load													
				I_{xx} in ⁴ /ft.	I_{xx} (eff) in ⁴ /ft.	S_{xx} in ³ /ft.	I_{xx} in ⁴ /ft.	I_{xx} (eff) in ⁴ /ft.	S_{xx} in ³ /ft.	1'	2'	3'	4'	5'	6'	7'	8'	9'	10'				
16	24	50	1.67	0.0376	0.0363	0.0628	0.0331	0.0344	0.0674	1098.2	392.5	174.4	98.1	62.8	43.6	32.0	24.5	19.4	15.7				
16	22	50	1.96	0.0481	0.0463	0.0816	0.0421	0.0438	0.0889	1178.2	510.0	226.7	127.5	81.6	56.7	41.6	31.9	25.2	20.4				
16	20	33	2.4	0.0661	0.0641	0.1176	0.0594	0.0613	0.1382	1184.6	490.0	217.8	122.5	78.4	54.4	40.0	30.6	24.2	19.6				
16	18	33	3.11	0.0872	0.0861	0.1570	0.0834	0.0845	0.2039	2040.9	654.2	290.7	163.5	104.7	72.7	53.4	40.9	32.3	26.2				
16	0.032"	19	0.69	0.0631	0.0631	0.1143	0.0631	0.0631	0.1643	110.0	55.0	36.7	25.5	16.3	11.4								
16	0.040"	19	1.52	0.0782	0.0782	0.1406	0.0782	0.0782	0.2013	170.91	85.5	57.0	39.3	25.2	17.5	12.8							

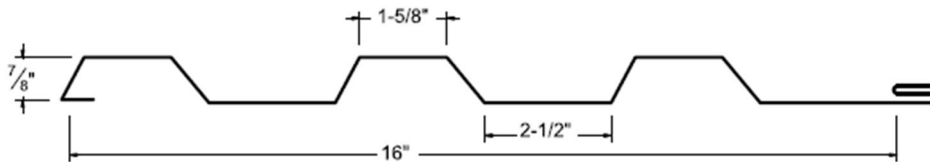

FIGURE 1-18 C1-A CLIP FLANGE PANELS

Contour C1-B Clip Flange

Panel profile and Fastening Schedule

All panels must be attached to support as described in Section 3.2 of the evaluation report using a minimum of two (2) #10 screws through the 18 ga. Standard Contour Clip. Fasteners must be placed inline with framing (perpendicular to the panel).

NEGATIVE LOAD

				SECTION PROPERTIES									ALLOWABLE UNIFORM LOADS, psf For various clip spacings (i.e. span values)									
Width, in.	Gauge	Yield ksi	Weight psf	Top in Compression			Bottom in Compression			Negative Load												
				I_{xx} in ⁴ /ft.	I_{xx} (eff) in ⁴ /ft.	S_{xx} in ³ /ft.	I_{xx} in ⁴ /ft.	I_{xx} (eff) in ⁴ /ft.	S_{xx} in ³ /ft.	1'	1.5'	2'	2.5'	3'	3.5'	4'	4.5'	5'				
12	24	50	1.29	0.0251	0.0232	0.0341	0.0187	0.0206	0.0456	195.0	178.1	161.3	144.4	127.5	110.6	93.8	76.9	60.0				
12	22	50	1.51	0.0326	0.0298	0.0450	0.0231	0.0258	0.0579	215.0	193.8	172.5	151.3	130.0	108.8	87.5	66.3	45.0				
12	20	33	1.84	0.0457	0.0418	0.0645	0.0322	0.0361	0.0903	215.0	193.8	172.5	151.3	130.0	108.8	87.5	66.3	45.0				
12	18	33	2.39	0.0620	0.0574	0.0876	0.0460	0.0507	0.1394	215.0	193.8	172.5	151.3	130.0	108.8	87.5	66.3	45.0				

POSITIVE LOAD

				SECTION PROPERTIES									ALLOWABLE UNIFORM LOADS, psf For various clip spacings (i.e. span values)										
Width, in.	Gauge	Yield ksi	Weight psf	Top in Compression			Bottom in Compression			Positive Load													
				I_{xx} in ⁴ /ft.	I_{xx} (eff) in ⁴ /ft.	S_{xx} in ³ /ft.	I_{xx} in ⁴ /ft.	I_{xx} (eff) in ⁴ /ft.	S_{xx} in ³ /ft.	1'	2'	3'	4'	5'	6'	7'	8'	9'	10'				
12	24	50	1.29	0.0251	0.0232	0.0341	0.0187	0.0206	0.0456	275.5	137.7	91.8	53.8	34.1	23.7	17.4	13.3	10.5					
12	22	50	1.51	0.0326	0.0298	0.0450	0.0231	0.0258	0.0579	294.6	147.3	98.2	70.3	45.0	31.3	23.0	17.6	13.9					
12	20	33	1.84	0.0457	0.0418	0.0645	0.0322	0.0361	0.0903	296.4	148.2	98.8	67.2	43.0	29.9	21.9	16.8	13.3					
12	18	33	2.39	0.0620	0.0574	0.0876	0.0460	0.0507	0.1394	510.9	255.5	162.2	91.3	58.4	40.6	29.8	22.8	18.0					
12	0.032"	19	0.52	0.045	0.045	0.0638	0.045	0.045	0.2299	27.3	13.6												
12	0.040"	19	1.14	0.055	0.055	0.0785	0.055	0.055	0.2805	47.7	21.4												

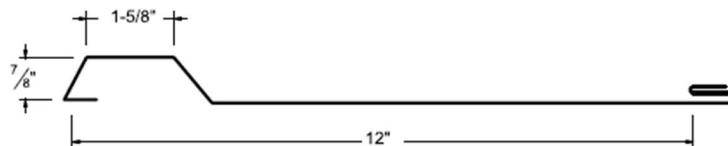

FIGURE 1-19 C1-B CLIP FLANGE PANELS

Contour C1-C Clip Flange

Contour C1-C Clip Flange

Panel profile and Fastening Schedule

All panels must be attached to support as described in Section 3.2 of the evaluation report using a minimum of two (2) #10 screws through the 18 ga. Standard Contour Clip. Fasteners must be placed inline with framing (perpendicular to the panel).

NEGATIVE LOAD

				SECTION PROPERTIES						ALLOWABLE UNIFORM LOADS, psf For various clip spacings (i.e. span values)									
Width, in.	Gauge	Yield ksi	Weight psf	Top in Compression			Bottom in Compression			Negative Load									
				I_{xx} in ⁴ /ft.	I_{xx} (eff) in ⁴ /ft.	S_{xx} in ³ /ft.	I_{xx} in ⁴ /ft.	I_{xx} (eff) in ⁴ /ft.	S_{xx} in ³ /ft.	1'	1.5'	2'	2.5'	3'	3.5'	4'	4.5'	5'	
16	24	50	1.84	0.0579	0.0548	0.0761	0.0473	0.0503	0.0848	165.0	151.3	137.5	123.8	110.0	96.3	82.5	68.8	55.0	
16	22	50	2.16	0.0720	0.0683	0.0979	0.0594	0.0630	0.1111	200.0	181.3	162.5	143.8	125.0	106.3	87.5	68.75	50.0	
16	20	33	2.64	0.0962	0.0923	0.1336	0.0827	0.0866	0.1700	200.0	181.3	162.5	143.8	125.0	106.3	87.5	68.75	50.0	
16	18	33	3.42	0.1230	0.1200	0.1710	0.1150	0.1160	0.2520	200.0	181.3	162.5	143.8	125.0	106.3	87.5	68.75	50.0	

POSITIVE LOAD

				SECTION PROPERTIES						ALLOWABLE UNIFORM LOADS, psf For various clip spacings (i.e. span values)										
Width, in.	Gauge	Yield ksi	Weight psf	Top in Compression			Bottom in Compression			Positive Load										
				I_{xx} in ⁴ /ft.	I_{xx} (eff) in ⁴ /ft.	S_{xx} in ³ /ft.	I_{xx} in ⁴ /ft.	I_{xx} (eff) in ⁴ /ft.	S_{xx} in ³ /ft.	1'	2'	3'	4'	5'	6'	7'	8'	9'	10'	
16	24	50	1.84	0.0579	0.0548	0.0761	0.0473	0.0503	0.0848	1235.5	475.6	211.4	118.9	76.1	52.9	38.8	29.7	23.5	19.0	
16	22	50	2.16	0.0720	0.0683	0.0979	0.0594	0.0630	0.1111	1323.6	611.9	271.9	153.0	97.9	68.0	50.0	38.2	30.2	24.5	
16	20	33	2.64	0.0962	0.0923	0.1336	0.0827	0.0866	0.1700	1331.8	556.7	247.4	139.2	89.1	61.9	45.4	34.8	27.5	22.3	
16	18	33	3.42	0.1230	0.1200	0.1710	0.1150	0.1160	0.2520	2296.4	712.5	316.7	178.1	114.0	79.2	58.2	44.5	35.2	28.5	
16	0.032"	19	0.69	0.0887	0.0887	0.1242	0.0887	0.0887	0.2090	186.36	92.63	41.14	23.2	14.8	10.3					
16	0.040"	19	1.52	0.1090	0.1090	0.1531	0.1090	0.1090	0.2570	290.91	142.26	63.2	35.6	22.8	15.8	11.6				

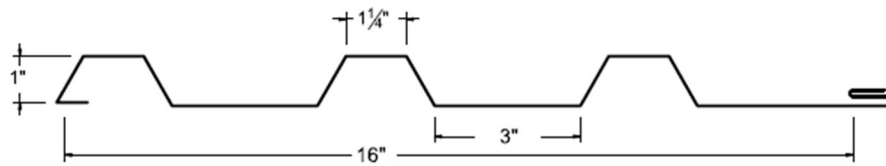

FIGURE 1-20 C1-C CLIP FLANGE PANELS

Contour C1-D Clip Flange

Panel profile and Fastening Schedule

All panels must be attached to support as described in Section 3.2 of the evaluation report using a minimum of two (2) #10 screws through the 18 ga. Standard Contour Clip. Fasteners must be placed inline with framing (perpendicular to the panel).

NEGATIVE LOAD

				SECTION PROPERTIES						ALLOWABLE UNIFORM LOADS, psf For various clip spacings (i.e. span values)									
Width, in.	Gauge	Yield ksi	Weight psf	Top in Compression			Bottom in Compression			Negative Load									
				I_{xx} in ⁴ /ft.	I_{xx} (eff) in ⁴ /ft.	S_{xx} in ³ /ft.	I_{xx} in ⁴ /ft.	I_{xx} (eff) in ⁴ /ft.	S_{xx} in ³ /ft.	1'	1.5'	2'	2.5'	3'	3.5'	4'	4.5'	5'	
12	24	50	1.47	0.0323	0.0293	0.0378	0.0219	0.0385	0.0376	185.0	166.6	148.1	129.7	111.3	92.8	73.3	55.9	37.5	
12	22	50	1.73	0.0408	0.0370	0.0484	0.0278	0.0316	0.0450	200.0	178.1	156.3	134.4	112.5	90.6	68.8	46.87	25.0	
12	20	33	1.47	0.0523	0.0476	0.0623	0.0361	0.0408	0.0556	200.0	178.1	156.3	134.4	112.5	90.6	68.8	46.87	25.0	
12	18	33	1.73	0.0670	0.0621	0.0799	0.0500	0.0549	0.0732	200.0	178.1	156.3	134.4	112.5	90.6	68.8	46.87	25.0	

POSITIVE LOAD

				SECTION PROPERTIES						ALLOWABLE UNIFORM LOADS, psf For various clip spacings (i.e. span values)										
Width, in.	Gauge	Yield ksi	Weight psf	Top in Compression			Bottom in Compression			Positive Load										
				I_{xx} in ⁴ /ft.	I_{xx} (eff) in ⁴ /ft.	S_{xx} in ³ /ft.	I_{xx} in ⁴ /ft.	I_{xx} (eff) in ⁴ /ft.	S_{xx} in ³ /ft.	1'	2'	3'	4'	5'	6'	7'	8'	9'	10'	
12	24	50	1.47	0.0323	0.0293	0.0378	0.0219	0.0385	0.0376	620.0	235.0	104.4	58.8	37.6	26.1	19.2	14.7	11.6		
12	22	50	1.73	0.0408	0.0370	0.0484	0.0278	0.0316	0.0450	664.6	281.3	125.0	70.3	45.0	31.3	23.0	17.6	13.9	11.3	
12	20	33	1.47	0.0523	0.0476	0.0623	0.0361	0.0408	0.0556	946.7	236.7	105.2	59.2	37.9	26.3	19.3	14.8	11.7		
12	18	33	1.73	0.0670	0.0621	0.0799	0.0500	0.0549	0.0732	1151.8	311.7	138.5	77.9	49.9	34.6	25.4	19.5	15.4	12.5	

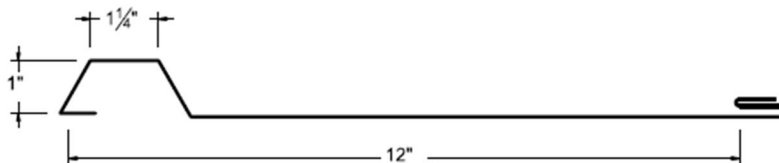

FIGURE 1-21 C1-D CLIP FLANGE PANELS

Contour C-2 Clip Flange

Contour C-2 Clip Flange

Panel profile and Fastening Schedule

All panels must be attached to support as described in Section 3.2 of the evaluation report using a minimum of two (2) #10 screws through the 18 ga. Standard Contour Clip. Fasteners must be placed inline with framing (perpendicular to the panel).

NEGATIVE LOAD

				SECTION PROPERTIES						ALLOWABLE UNIFORM LOADS, psf For various clip spacings (i.e. span values)									
Width, in.	Gauge	Yield ksi	Weight psf	Top in Compression			Bottom in Compression			Negative Load									
				I_{xx} in ⁴ /ft.	I_{xx} (eff) in ⁴ /ft.	S_{xx} in ³ /ft.	I_{xx} in ⁴ /ft.	I_{xx} (eff) in ⁴ /ft.	S_{xx} in ³ /ft.	1'	1.5'	2'	2.5'	3'	3.5'	4'	4.5'	5'	
16	24	50	1.67	0.0200	0.0230	0.0407	0.0302	0.0272	0.0494	150.0	137.5	125.0	112.5	100.0	87.5	75.0	62.5	50.0	
16	22	50	1.96	0.0255	0.0292	0.0542	0.0383	0.0346	0.0646	212.5	192.2	171.9	151.6	131.3	110.9	90.6	70.3	50.0	
16	20	33	2.4	0.0361	0.0411	0.0849	0.0526	0.0478	0.0908	212.5	192.2	171.9	151.6	131.3	110.9	90.6	70.3	50.0	
16	18	33	3.11	0.0541	0.0589	0.1150	0.0706	0.0658	0.1230	212.5	192.2	171.9	151.6	131.3	110.9	90.6	70.3	50.0	

POSITIVE LOAD

				SECTION PROPERTIES						ALLOWABLE UNIFORM LOADS, psf For various clip spacings (i.e. span values)									
Width, in.	Gauge	Yield ksi	Weight psf	Top in Compression			Bottom in Compression			Positive Load									
				I_{xx} in ⁴ /ft.	I_{xx} (eff) in ⁴ /ft.	S_{xx} in ³ /ft.	I_{xx} in ⁴ /ft.	I_{xx} (eff) in ⁴ /ft.	S_{xx} in ³ /ft.	1'	2'	3'	4'	5'	6'	7'	8'	9'	10'
16	24	50	1.67	0.0200	0.0230	0.0407	0.0302	0.0272	0.0494	509.1	254.4	113.1	63.6	40.7	28.3	20.8	15.9	12.6	10.2
16	22	50	1.96	0.0255	0.0292	0.0542	0.0383	0.0346	0.0646	545.5	272.73	150.56	84.7	54.2	37.6	27.65	21.2	16.7	13.6
16	20	33	2.4	0.0361	0.0411	0.0849	0.0526	0.0478	0.0908	548.2	274.09	157.22	88.4	56.6	39.3	28.88	22.1	17.5	14.2
16	18	33	3.11	0.0541	0.0589	0.1150	0.0706	0.0658	0.1230	943.6	471.8	213.0	119.79	76.7	53.2	39.12	30.0	23.7	19.2
16	0.032"	19	0.69	0.0511	0.0511	0.1840	0.0511	0.0511	0.0910	78.2	39.1	26.1	19.6	15.6	13.0	11.17			
16	0.040"	19	1.52	0.0639	0.0639	0.2250	0.0639	0.0639	0.1110	122.7	61.4	40.9	30.7	24.6	20.5	15.65	12.0		

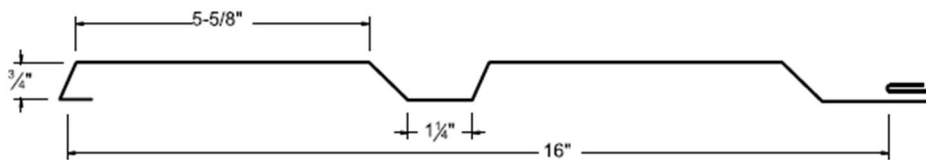

FIGURE 1-22 C-2 CLIP FLANGE PANELS

Contour C2-A Clip Flange

Panel profile and Fastening Schedule

All panels must be attached to support as described in Section 3.2 of the evaluation report using a minimum of two (2) #10 screws through the 18 ga. Standard Contour Clip. Fasteners must be placed inline with framing (perpendicular to the panel).

NEGATIVE LOAD

				SECTION PROPERTIES						ALLOWABLE UNIFORM LOADS, psf For various clip spacings (i.e. span values)									
Width, in.	Gauge	Yield ksi	Weight psf	Top in Compression			Bottom in Compression			Negative Load									
				I_{xx} in ⁴ /ft.	I_{xx} (eff) in ⁴ /ft.	S_{xx} in ³ /ft.	I_{xx} in ⁴ /ft.	I_{xx} (eff) in ⁴ /ft.	S_{xx} in ³ /ft.	1'	1.5'	2'	2.5'	3'	3.5'	4'	4.5'	5'	
12	24	50	1.40	0.0345	0.0364	0.0585	0.0409	0.0390	0.0673	180.0	164.6	149.4	134.1	118.7	103.4	88.1	72.8	57.5	
12	22	50	1.65	0.0436	0.0460	0.0763	0.0519	0.0495	0.0881	250.0	225.0	200.0	175.0	150.0	125.0	100.0	75.0	50.0	
12	20	33	2.01	0.0607	0.0638	0.1128	0.0715	0.0684	0.1276	250.0	225.0	200.0	175.0	150.0	125.0	100.0	75.0	50.0	
12	18	33	2.60	0.0830	0.0871	0.1573	0.0970	0.0929	0.1743	250.0	225.0	200.0	175.0	150.0	125.0	100.0	75.0	50.0	

POSITIVE LOAD

				SECTION PROPERTIES						ALLOWABLE UNIFORM LOADS, psf For various clip spacings (i.e. span values)										
Width, in.	Gauge	Yield ksi	Weight psf	Top in Compression			Bottom in Compression			Positive Load										
				I_{xx} in ⁴ /ft.	I_{xx} (eff) in ⁴ /ft.	S_{xx} in ³ /ft.	I_{xx} in ⁴ /ft.	I_{xx} (eff) in ⁴ /ft.	S_{xx} in ³ /ft.	1'	2'	3'	4'	5'	6'	7'	8'	9'	10'	
12	24	50	1.40	0.0345	0.0364	0.0585	0.0409	0.0390	0.0673	731.8	365.4	162.4	91.3	58.5	40.6	29.8	22.8	18.0	14.6	
12	22	50	1.65	0.0436	0.0460	0.0763	0.0519	0.0495	0.0881	784.6	392.3	211.9	119.2	76.3	53.0	38.9	29.8	23.6	19.1	
12	20	33	2.01	0.0607	0.0638	0.1128	0.0715	0.0684	0.1276	790.0	395.0	208.9	117.5	75.2	52.2	38.4	29.4	23.2	18.8	
12	18	33	2.60	0.0830	0.0871	0.1573	0.0970	0.0929	0.1743	1360.0	655.4	291.3	163.9	104.9	72.8	53.5	41.0	32.4	26.2	

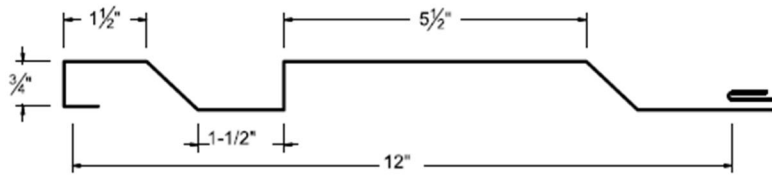

FIGURE 1-23 C2-A CLIP FLANGE PANELS

Contour C2-B Clip Flange

Panel profile and Fastening Schedule

All panels must be attached to support as described in Section 3.2 of the evaluation report using a minimum of two (2) #10 screws through the 18 ga. Standard Contour Clip. Fasteners must be placed inline with framing (perpendicular to the panel).

NEGATIVE LOAD

				SECTION PROPERTIES						ALLOWABLE UNIFORM LOADS, psf For various clip spacings (i.e. span values)									
Width, in.	Gauge	Yield ksi	Weight psf	Top in Compression			Bottom in Compression			Negative Load									
				I_{xx} in ⁴ /ft.	I_{xx} (eff) in ⁴ /ft.	S_{xx} in ³ /ft.	I_{xx} in ⁴ /ft.	I_{xx} (eff) in ⁴ /ft.	S_{xx} in ³ /ft.	1'	1.5'	2'	2.5'	3'	3.5'	4'	4.5'	5'	
12	24	50	1.40	0.0347	0.0378	0.0587	0.0454	0.0423	0.0720	207.5	186.3	165.0	143.8	122.5	101.3	80.0	58.75	37.5	
12	22	50	1.65	0.0439	0.0479	0.0768	0.0578	0.0537	0.0945	187.5	170.3	153.1	135.9	118.8	101.6	84.4	67.2	50.0	
12	20	33	2.01	0.0611	0.0666	0.1130	0.0800	0.0745	0.1372	187.5	170.3	153.1	135.9	118.8	101.6	84.4	67.2	50.0	
12	18	33	2.60	0.0850	0.0919	0.1616	0.1090	0.1020	0.1885	187.5	170.3	153.1	135.9	118.8	101.6	84.4	67.2	50.0	

POSITIVE LOAD

				SECTION PROPERTIES						ALLOWABLE UNIFORM LOADS, psf For various clip spacings (i.e. span values)										
Width, in.	Gauge	Yield ksi	Weight psf	Top in Compression			Bottom in Compression			Positive Load										
				I_{xx} in ⁴ /ft.	I_{xx} (eff) in ⁴ /ft.	S_{xx} in ³ /ft.	I_{xx} in ⁴ /ft.	I_{xx} (eff) in ⁴ /ft.	S_{xx} in ³ /ft.	1'	2'	3'	4'	5'	6'	7'	8'	9'	10'	
12	24	50	1.40	0.0347	0.0378	0.0587	0.0454	0.0423	0.0720	731.8	365.9	163.1	91.8	58.7	40.8	30.0	22.9	18.1	14.7	
12	22	50	1.65	0.0439	0.0479	0.0768	0.0578	0.0537	0.0945	784.6	392.3	213.3	120.0	76.8	53.3	39.2	30.0	23.7	19.2	
12	20	33	2.01	0.0611	0.0666	0.1130	0.0800	0.0745	0.1372	790.0	395.0	209.3	117.7	75.3	52.3	38.4	29.4	23.3	18.8	
12	18	33	2.60	0.0850	0.0919	0.1616	0.1090	0.1020	0.1885	1360.0	673.3	299.3	168.3	107.7	74.8	55.0	42.1	33.3	26.9	

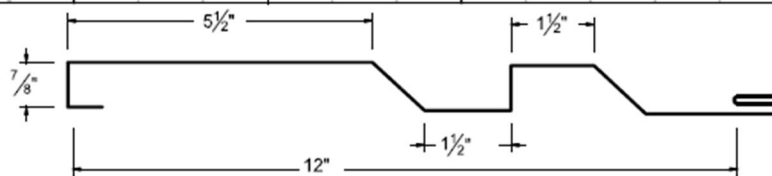

FIGURE 1-24 C2-B CLIP FLANGE PANELS

Contour C2-C Clip Flange

Panel profile and Fastening Schedule

All panels must be attached to support as described in Section 3.2 of the evaluation report using a minimum of two (2) #10 screws through the 18 ga. Standard Contour Clip. Fasteners must be placed inline with framing (perpendicular to the panel).

NEGATIVE LOAD

Width, in.	Gauge	Yield ksi	Weight psf	SECTION PROPERTIES									ALLOWABLE UNIFORM LOADS, psf For various clip spacings (i.e. span values)								
				Top in Compression			Bottom in Compression			Negative Load											
				I_{xx} in ⁴ /ft.	I_{xx} (net) in ⁴ /ft.	S_{xx} in ³ /ft.	I_{xx} in ⁴ /ft.	I_{xx} (net) in ⁴ /ft.	S_{xx} in ³ /ft.	1'	1.5'	2'	2.5'	3'	3.5'	4'	4.5'	5'			
12	24	50	1.4	0.0318	0.0342	0.0591	0.04	0.0376	0.0707	162.5	150	137.5	125	112.5	100	87.5	75	62.5			
12	22	50	1.65	0.0404	0.0434	0.0784	0.0508	0.0478	0.093	187.5	170.3	153.1	139.9	118.8	101.6	84.4	67.2	50			
12	20	33	2.01	0.0573	0.061	0.1209	0.0701	0.0664	0.1367	187.5	170.3	153.1	139.9	118.8	101.6	84.4	67.2	50			
12	18	33	2.6	0.081	0.0851	0.1817	0.095	0.0909	0.1873	187.5	170.3	153.1	139.9	118.8	101.6	84.4	67.2	50			

POSITIVE LOAD

Width, in.	Gauge	Yield ksi	Weight psf	SECTION PROPERTIES									ALLOWABLE UNIFORM LOADS, psf For various clip spacings (i.e. span values)									
				Top in Compression			Bottom in Compression			Positive Load												
				I_{xx} in ⁴ /ft.	I_{xx} (net) in ⁴ /ft.	S_{xx} in ³ /ft.	I_{xx} in ⁴ /ft.	I_{xx} (net) in ⁴ /ft.	S_{xx} in ³ /ft.	1'	2'	3'	4'	5'	6'	7'	8'	9'	10'			
12	24	50	1.4	0.0318	0.0342	0.0591	0.04	0.0376	0.0707	735.5	367.7	164	92.3	59.1	41	30.1	23.1	18.2	14.8			
12	22	50	1.65	0.0404	0.0434	0.0784	0.0508	0.0478	0.093	788.2	394.1	217.8	122.5	78.4	54.4	40	30.6	24.2	19.6			
12	20	33	2.01	0.0573	0.061	0.1209	0.0701	0.0664	0.1367	791.8	395.9	223.9	125.9	80.6	56	41.1	31.5	24.9	20.2			
12	18	33	2.6	0.081	0.0851	0.1817	0.095	0.0909	0.1873	1363.6	681.8	336.5	189.3	121.1	84.1	61.8	47.3	37.4	30.3			

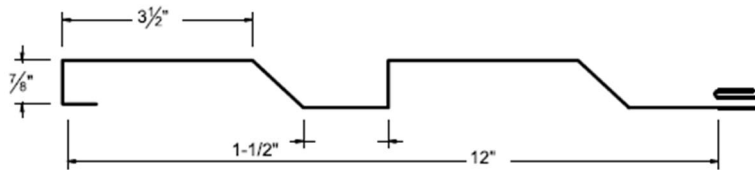

FIGURE 1-25 C2-C CLIP FLANGE PANELS

Contour C-3 Clip Flange

Panel profile and Fastening Schedule

All panels must be attached to support as described in Section 3.2 of the evaluation report using a minimum of two (2) #10 screws through the 18 ga. Standard Contour Clip. Fasteners must be placed inline with framing (perpendicular to the panel).

NEGATIVE LOAD

Width, in.	Gauge	Yield ksi	Weight psf	SECTION PROPERTIES									ALLOWABLE UNIFORM LOADS, psf For various clip spacings (i.e. span values)								
				Top in Compression			Bottom in Compression			Negative Load											
				I_{xx} in ⁴ /ft.	I_{xx} (net) in ⁴ /ft.	S_{xx} in ³ /ft.	I_{xx} in ⁴ /ft.	I_{xx} (net) in ⁴ /ft.	S_{xx} in ³ /ft.	1'	1.5'	2'	2.5'	3'	3.5'	4'	4.5'	5'			
16	24	50	1.61	0.03	0.0279	0.044	0.0227	0.0248	0.0481	195	176.9	158.8	140.6	122.5	104.4	86.3	68.1	50			
16	22	50	1.89	0.0383	0.0357	0.0575	0.0293	0.0319	0.0625	200	181.3	162.5	143.8	125	106.3	87.5	68.8	50			
16	20	33	2.31	0.0541	0.0506	0.0831	0.042	0.0455	0.0797	200	181.3	162.5	143.8	125	106.3	87.5	68.8	50			
16	18	33	3	0.072	0.0685	0.1116	0.0601	0.0635	0.105	200	181.3	162.5	143.8	125	106.3	87.5	68.8	50			

POSITIVE LOAD

Width, in.	Gauge	Yield ksi	Weight psf	SECTION PROPERTIES									ALLOWABLE UNIFORM LOADS, psf For various clip spacings (i.e. span values)									
				Top in Compression			Bottom in Compression			Positive Load												
				I_{xx} in ⁴ /ft.	I_{xx} (net) in ⁴ /ft.	S_{xx} in ³ /ft.	I_{xx} in ⁴ /ft.	I_{xx} (net) in ⁴ /ft.	S_{xx} in ³ /ft.	1'	2'	3'	4'	5'	6'	7'	8'	9'	10'			
16	24	50	1.61	0.03	0.0279	0.044	0.0227	0.0248	0.0481	800.9	275	122.2	68.8	44	30.6	22.5	17.2	13.6	11			
16	22	50	1.89	0.0383	0.0357	0.0575	0.0293	0.0319	0.0625	858.2	359.4	159.7	89.8	57.5	39.9	29.34	22.5	17.8	14.4			
16	20	33	2.31	0.0541	0.0506	0.0831	0.042	0.0455	0.0797	862.7	332.1	147.6	83	53.1	36.9	27.11	20.8	16.4	13.3			
16	18	33	3	0.072	0.0685	0.1116	0.0601	0.0635	0.105	1484.6	437.5	194.4	109.4	70	48.6	35.71	27.3	21.6	17.5			
16	0.032"	19	0.72	0.0519	0.0519	0.0809	0.0519	0.0519	0.1883	123.6	33.9	15.1										
16	0.040"	19	1.56	0.0639	0.0639	0.0998	0.0639	0.0639	0.23	192.7	52	23.1	13									

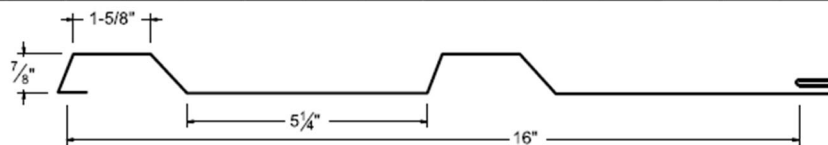

FIGURE 1-26 C-3 CLIP FLANGE PANELS

Contour C-4 Clip Flange

Panel profile and Fastening Schedule

All panels must be attached to support as described in Section 3.2 of the evaluation report using a minimum of two (2) #10 screws through the 18 ga. Standard Contour Clip. Fasteners must be placed inline with framing (perpendicular to the panel).

NEGATIVE LOAD

				SECTION PROPERTIES						ALLOWABLE UNIFORM LOADS, psf For various clip spacings (i.e. span values)									
Width, in.	Gauge	Yield ksi	Weight psf	Top in Compression			Bottom in Compression			Negative Load									
				I_{ox} in ⁴ /ft.	$I_{ox(eff)}$ in ⁴ /ft.	S_{ox} in ³ /ft.	I_{ox} in ⁴ /ft.	$I_{ox(eff)}$ in ⁴ /ft.	S_{ox} in ³ /ft.	1'	1.5'	2'	2.5'	3'	3.5'	4'	4.5'	5'	
16	24	50	1.73	0.0564	0.0544	0.0586	0.0496	0.0515	0.0605	187.5	168.8	150	131.3	112.5	93.8	75	56.3	37.5	
16	22	50	2.03	0.07	0.0678	0.0744	0.0624	0.0646	0.0732	170	153.4	136.9	120.3	103.8	87.2	70.6	54.1	37.5	
16	20	33	2.48	0.0902	0.0886	0.0966	0.0849	0.0864	0.0937	170	153.4	136.9	120.3	103.8	87.2	70.6	54.1	37.5	
16	18	33	3.22	0.116	0.116	0.1242	0.115	0.115	0.1237	170	153.4	136.9	120.3	103.8	87.2	70.6	54.1	37.5	

POSITIVE LOAD

				SECTION PROPERTIES						ALLOWABLE UNIFORM LOADS, psf For various clip spacings (i.e. span values)										
Width, in.	Gauge	Yield ksi	Weight psf	Top in Compression			Bottom in Compression			Positive Load										
				I_{ox} in ⁴ /ft.	$I_{ox(eff)}$ in ⁴ /ft.	S_{ox} in ³ /ft.	I_{ox} in ⁴ /ft.	$I_{ox(eff)}$ in ⁴ /ft.	S_{ox} in ³ /ft.	1'	2'	3'	4'	5'	6'	7'	8'	9'	10'	
16	24	50	1.73	0.0564	0.0544	0.0586	0.0496	0.0515	0.0605	967.27	366.3	162.8	91.6	58.6	40.7	29.9	22.9	18.1	14.7	
16	22	50	2.03	0.07	0.0678	0.0744	0.0624	0.0646	0.0732	1037.3	457.5	203.3	114.4	73.2	50.8	37.4	28.6	22.6	18.3	
16	20	33	2.48	0.0902	0.0886	0.0966	0.0849	0.0864	0.0937	1044.6	390.4	173.5	97.6	62.5	43.4	31.9	24.4	19.3	15.6	
16	18	33	3.22	0.116	0.116	0.1242	0.115	0.115	0.1237	1800.9	515.4	229.1	128.9	82.5	57.3	42.1	32.2	25.5	20.6	

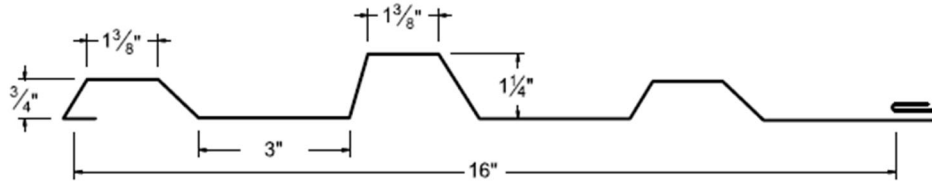

FIGURE 1-27 C-4 CLIP FLANGE PANELS

Contour C5-A Clip Flange

Panel profile and Fastening Schedule

All panels must be attached to support as described in Section 3.2 of the evaluation report using a minimum of two (2) #10 screws through the 18 ga. Standard Contour Clip. Fasteners must be placed inline with framing (perpendicular to the panel).

NEGATIVE LOAD

				SECTION PROPERTIES						ALLOWABLE UNIFORM LOADS, psf For various clip spacings (i.e. span values)									
Width, in.	Gauge	Yield ksi	Weight psf	Top in Compression			Bottom in Compression			Negative Load									
				I_{ox} in ⁴ /ft.	$I_{ox(eff)}$ in ⁴ /ft.	S_{ox} in ³ /ft.	I_{ox} in ⁴ /ft.	$I_{ox(eff)}$ in ⁴ /ft.	S_{ox} in ³ /ft.	1'	1.5'	2'	2.5'	3'	3.5'	4'	4.5'	5'	
16	24	50	1.3	0.032	0.033	0.06	0.034	0.033	0.068	150	134.4	118.8	103.1	87.5	71.9	56.3	40.6	25.0	
16	22	50	1.53	0.041	0.041	0.08	0.043	0.043	0.091	162.5	146.9	131.3	115.6	100.0	84.4	68.8	53.1	37.5	
16	20	33	1.87	0.059	0.059	0.121	0.059	0.059	0.138	162.5	146.9	131.3	115.6	100.0	84.4	68.8	53.1	37.5	
16	18	33	2.43	0.082	0.081	0.178	0.081	0.082	0.201	162.5	146.9	131.3	115.6	100.0	84.4	68.8	53.1	37.5	

POSITIVE LOAD

				SECTION PROPERTIES						ALLOWABLE UNIFORM LOADS, psf For various clip spacings (i.e. span values)										
Width, in.	Gauge	Yield ksi	Weight psf	Top in Compression			Bottom in Compression			Positive Load										
				I_{ox} in ⁴ /ft.	$I_{ox(eff)}$ in ⁴ /ft.	S_{ox} in ³ /ft.	I_{ox} in ⁴ /ft.	$I_{ox(eff)}$ in ⁴ /ft.	S_{ox} in ³ /ft.	1'	2'	3'	4'	5'	6'	7'	8'	9'	10'	
16	24	50	1.3	0.032	0.033	0.06	0.034	0.033	0.068	1446.4	375.00	166.7	93.8	60.00	41.7	30.6	23.4	18.5	15.00	
16	22	50	1.53	0.041	0.041	0.08	0.043	0.043	0.091	1545.5	500.00	222.2	125.00	80.00	55.6	40.8	31.3	24.7	20.00	
16	20	33	1.87	0.059	0.059	0.121	0.059	0.059	0.138	1552.7	504.2	224.1	126.00	80.7	56.00	41.2	31.5	24.9	20.2	
16	18	33	2.43	0.082	0.081	0.178	0.081	0.082	0.201	2110.0	741.7	329.6	185.4	118.7	82.4	60.5	46.4	36.6	29.7	



FIGURE 1-28 C5-A CLIP FLANGE PANELS

Contour C-6 Clip Flange

Panel profile and Fastening Schedule

All panels must be attached to support as described in Section 3.2 of the evaluation report using a minimum of two (2) #10 screws through the 18 ga. Standard Contour Clip. Fasteners must be placed inline with framing (perpendicular to the panel).

NEGATIVE LOAD

				SECTION PROPERTIES						ALLOWABLE UNIFORM LOADS, psf For various clip spacings (i.e. span values)									
Width, in.	Gauge	Yield ksi	Weight psf	Top in Compression			Bottom in Compression			Negative Load									
				I_{xx} in ⁴ /ft.	$I_{xx(eff)}$ in ⁴ /ft.	S_{xx} in ³ /ft.	I_{xx} in ⁴ /ft.	$I_{xx(eff)}$ in ⁴ /ft.	S_{xx} in ³ /ft.	1'	1.5'	2'	2.5'	3'	3.5'	4'	4.5'	5'	
12	24	50	1.52	0.074	0.0798	0.0934	0.0942	0.0883	0.1142	187.5	170.3	153.1	135.9	118.8	101.6	84.4	67.2	50	
12	22	50	1.77	0.0933	0.101	0.1228	0.1196	0.112	0.1507	187.5	168.8	150	131.3	112.5	93.8	75	56.3	37.5	
12	20	33	2.16	0.1301	0.1402	0.184	0.165	0.1548	0.2216	187.5	168.8	150	131.3	112.5	93.8	75	56.3	37.5	
12	18	33	2.8	0.182	0.1947	0.2709	0.226	0.2132	0.3149	187.5	168.8	150	13.33	112.5	93.8	75	56.3	37.5	

POSITIVE LOAD

				SECTION PROPERTIES						ALLOWABLE UNIFORM LOADS, psf For various clip spacings (i.e. span values)									
Width, in.	Gauge	Yield ksi	Weight psf	Top in Compression			Bottom in Compression			Positive Load									
				I_{xx} in ⁴ /ft.	$I_{xx(eff)}$ in ⁴ /ft.	S_{xx} in ³ /ft.	I_{xx} in ⁴ /ft.	$I_{xx(eff)}$ in ⁴ /ft.	S_{xx} in ³ /ft.	1'	2'	3'	4'	5'	6'	7'	8'	9'	10'
12	24	50	1.52	0.074	0.0798	0.0934	0.0942	0.0883	0.1142	1065.5	532.7	259.5	146	93.4	64.9	47.7	36.5	28.8	23.4
12	22	50	1.77	0.0933	0.101	0.1228	0.1196	0.112	0.1507	1141.8	570.9	341.1	191.9	122.8	85.28	62.65	48	37.9	30.7
12	20	33	2.16	0.1301	0.1402	0.184	0.165	0.1548	0.2216	1149.1	574.6	340.7	191.7	122.7	85.2	62.59	47.9	37.9	30.7
12	18	33	2.8	0.182	0.1947	0.2709	0.226	0.2132	0.3149	1982.7	991.4	501.7	282.2	180.6	125.4	92.14	70.55	55.7	45.2
12	0.032'	19	0.52	0.171	0.171	0.3115	0.171	0.171	0.2441	150.0	75.0	50.0	37.5	30.0	25.0	21.43	17.67	14	11.3
12	0.04	19	1.14	0.21	0.21	0.383	0.21	0.21	0.2999	233.6	116.8	77.9	58.4	46.7	38.9	33.38	26.28	20.8	16.8

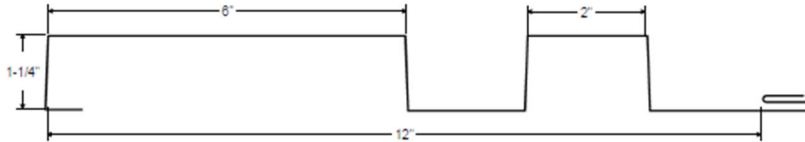

FIGURE 1-29 C-6 CLIP FLANGE PANELS

Contour C6-A Clip Flange

Panel profile and Fastening Schedule

All panels must be attached to support as described in Section 3.2 of the evaluation report using a minimum of two (2) #10 screws through the 18 ga. Standard Contour Clip. Fasteners must be placed inline with framing (perpendicular to the panel).

NEGATIVE LOAD

				SECTION PROPERTIES						ALLOWABLE UNIFORM LOADS, psf For various clip spacings (i.e. span values)									
Width, in.	Gauge	Yield ksi	Weight psf	Top in Compression			Bottom in Compression			Negative Load									
				I_{xx} in ⁴ /ft.	$I_{xx(eff)}$ in ⁴ /ft.	S_{xx} in ³ /ft.	I_{xx} in ⁴ /ft.	$I_{xx(eff)}$ in ⁴ /ft.	S_{xx} in ³ /ft.	1'	1.5'	2'	2.5'	3'	3.5'	4'	4.5'	5'	
12	2.4	50	1.3	0.0271	0.0262	0.0344	0.0241	0.0249	0.0583	150.0	137.5	125	112.5	100	87.5	75.0	62.5	50.0	
12	2.2	50	1.52	0.0354	0.0339	0.0458	0.0303	0.0318	0.0623	175.0	160.9	146.9	132.8	118.8	104.7	90.9	76.6	62.5	
12	2	33	1.86	0.0516	0.0491	0.069	0.0432	0.0456	0.0849	175.0	160.9	146.9	132.8	118.8	104.7	90.9	76.6	62.5	
12	18	33	2.42	0.074	0.0699	0.1015	0.06	0.064	0.1103	175.0	160.9	146.9	132.8	118.8	104.7	90.9	76.6	62.5	

POSITIVE LOAD

				SECTION PROPERTIES						ALLOWABLE UNIFORM LOADS, psf For various clip spacings (i.e. span values)									
Width, in.	Gauge	Yield ksi	Weight psf	Top in Compression			Bottom in Compression			Positive Load									
				I_{xx} in ⁴ /ft.	$I_{xx(eff)}$ in ⁴ /ft.	S_{xx} in ³ /ft.	I_{xx} in ⁴ /ft.	$I_{xx(eff)}$ in ⁴ /ft.	S_{xx} in ³ /ft.	1'	2'	3'	4'	5'	6'	7'	8'	9'	10'
12	2.4	50	1.3	0.0271	0.0262	0.0344	0.0241	0.0249	0.0583	359.1	179.6	95.6	53.8	34.4	23.9	17.6	13.4	10.6	
12	2.2	50	1.52	0.0354	0.0339	0.0458	0.0303	0.0318	0.0623	273.6	136.8	91.2	68.4	45.8	31.8	23.4	17.9	14.1	11.5
12	2	33	1.86	0.0516	0.0491	0.069	0.0432	0.0456	0.0849	386.4	193.2	127.8	71.9	46	31.9	23.5	18	14.2	11.5
12	18	33	2.42	0.074	0.0699	0.1015	0.06	0.064	0.1103	666.4	333.2	188	105.7	67.7	47	34.5	26.4	20.9	16.9



FIGURE 1-30 C6-A CLIP FLANGE PANELS

Contour C8-A Clip Flange

Panel profile and Fastening Schedule

All panels must be attached to support as described in Section 3.2 of the evaluation report using a minimum of two (2) #10 screws through the 18 ga. Standard Contour Clip. Fasteners must be placed inline with framing (perpendicular to the panel) .

NEGATIVE LOAD

				SECTION PROPERTIES						ALLOWABLE UNIFORM LOADS, psf For various clip spacings (i.e. span values)									
Width, in.	Gauge	Yield ksi	Weight psf	Top in Compression			Bottom in Compression			Negative Load									
				I_{xx} in ⁴ /ft.	I_{xx} (eff) in ⁴ /ft.	S_{xx} in ³ /ft.	I_{xx} in ⁴ /ft.	I_{xx} (eff) in ⁴ /ft.	S_{xx} in ³ /ft.	1'	1.5'	2'	2.5'	3'	3.5'	4'	4.5'	5'	
12	24	50	1.6	0.1159	0.1169	0.1182	0.1193	0.1183	0.1381	162.5	150	137.5	125	112.5	100	87.5	75.0	62.5	
12	22	50	1.87	0.1467	0.1478	0.1547	0.1507	0.1495	0.1827	150.00	137.5	125.00	112.5	100.00	87.5	75.00	62.5	50.0	
12	20	33	2.28	0.2052	0.2059	0.2297	0.2079	0.2071	0.2729	150.00	137.5	125.00	112.5	100.00	87.5	75.00	62.5	50.0	
12	18	33	2.96	0.288	0.2877	0.3374	0.287	0.2873	0.3896	150.00	137.5	125.00	112.5	100.00	87.5	75.00	62.5	50.0	

POSITIVE LOAD

				SECTION PROPERTIES						ALLOWABLE UNIFORM LOADS, psf For various clip spacings (i.e. span values)									
Width, in.	Gauge	Yield ksi	Weight psf	Top in Compression			Bottom in Compression			Positive Load									
				I_{xx} in ⁴ /ft.	I_{xx} (eff) in ⁴ /ft.	S_{xx} in ³ /ft.	I_{xx} in ⁴ /ft.	I_{xx} (eff) in ⁴ /ft.	S_{xx} in ³ /ft.	1'	2'	3'	4'	5'	6'	7'	8'	9'	10'
12	24	50	1.6	0.1159	0.1169	0.1182	0.1193	0.1183	0.1381	1060	530	327.8	184.4	118	81.9	60.2	46.1	36.4	29.5
12	22	50	1.87	0.1467	0.1478	0.1547	0.1507	0.1495	0.1827	1136.4	568.2	378.8	241.7	154.7	107.4	78.93	60.4	47.8	38.7
12	20	33	2.28	0.2052	0.2059	0.2297	0.2079	0.2071	0.2729	1145.5	572.7	381.8	239.3	153.1	106.3	78.13	59.8	47.3	38.3
12	18	33	2.96	0.288	0.2877	0.3374	0.287	0.2873	0.3896	1975.5	987.7	624.8	351.5	224.9	156.2	114.8	87.86	69.4	56.2
12	0.032"	19	0.64	0.239	0.239	0.3014	0.239	0.239	0.3716	149.1	74.6	49.7	37.3	29.8	24.5	18	13.8	10.9	
12	0.040"	19	1.23	0.295	0.295	0.3712	0.295	0.295	0.4572	232.7	116.4	77.6	58.2	46.6	37.8	27.8	21.3	16.8	13.6

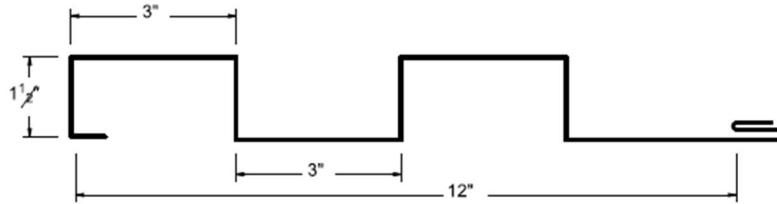

FIGURE 1-31 C8-A CLIP FLANGE PANELS

Contour C8-B Clip Flange

Panel profile and Fastening Schedule

All panels must be attached to support as described in Section 3.2 of the evaluation report using a minimum of two (2) #10 screws through the 18 ga. Standard Contour Clip. Fasteners must be placed inline with framing (perpendicular to the panel) .

NEGATIVE LOAD

				SECTION PROPERTIES						ALLOWABLE UNIFORM LOADS, psf For various clip spacings (i.e. span values)								
Width, in.	Gauge	Yield ksi	Weight psf	Top in Compression			Bottom in Compression			Negative Load								
				I_{xx} in ⁴ /ft.	I_{xx} (eff) in ⁴ /ft.	S_{xx} in ³ /ft.	I_{xx} in ⁴ /ft.	I_{xx} (eff) in ⁴ /ft.	S_{xx} in ³ /ft.	1'	1.5'	2'	2.5'	3'	3.5'	4'	4.5'	5'
16	24	50	1.85	0.0621	0.0634	0.0713	0.0666	0.0623	0.0847	150	135.9	121.9	107.8	93.8	79.7	65.6	51.6	37.5
16	22	50	2.17	0.0797	0.0812	0.0946	0.0849	0.0834	0.113	162.5	146.9	131.3	115.6	100.0	84.4	68.8	53.1	37.5
16	20	33	2.65	0.114	0.115	0.144	0.119	0.117	0.172	162.5	146.9	131.3	115.6	100.0	84.4	68.8	53.1	37.5
16	18	33	3.44	0.163	0.164	0.216	0.167	0.166	0.255	162.5	146.9	131.3	115.6	100.0	84.4	68.8	53.1	37.5

POSITIVE LOAD

				SECTION PROPERTIES						ALLOWABLE UNIFORM LOADS, psf For various clip spacings (i.e. span values)									
Width, in.	Gauge	Yield ksi	Weight psf	Top in Compression			Bottom in Compression			Positive Load									
				I_{xx} in ⁴ /ft.	I_{xx} (eff) in ⁴ /ft.	S_{xx} in ³ /ft.	I_{xx} in ⁴ /ft.	I_{xx} (eff) in ⁴ /ft.	S_{xx} in ³ /ft.	1'	2'	3'	4'	5'	6'	7'	8'	9'	10'
16	24	50	1.85	0.0621	0.0634	0.0713	0.0666	0.0623	0.0847	1067.3	445.6	198.1	111.4	71.3	49.5	36.4	27.9	22.0	17.8
16	22	50	2.17	0.0797	0.0812	0.0946	0.0849	0.0834	0.113	1143.6	571.8	262.8	147.8	94.6	65.7	48.3	37.0	29.2	23.7
16	20	33	2.65	0.114	0.115	0.144	0.119	0.117	0.172	1151.8	575.9	266.7	150.00	96.00	66.7	49.0	37.5	29.6	24.0
16	18	33	3.44	0.163	0.164	0.216	0.167	0.166	0.255	1986.4	900.0	400.0	225.0	114.0	100.0	73.5	56.3	44.4	36.0

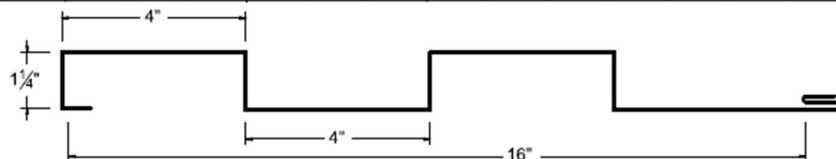

FIGURE 1-32 C8-B CLIP FLANGE PANELS

Contour CR-B Clip Flange

Panel profile and Fastening Schedule

All panels must be attached to support as described in Section 3.2 of the evaluation report using a minimum of two (2) #10 screws through the 18 ga. Standard Contour Clip. Fasteners must be placed inline with framing (perpendicular to the panel) .

NEGATIVE LOAD

Width, in.	Gauge	Yield ksi	Weight psf	SECTION PROPERTIES									ALLOWABLE UNIFORM LOADS, psf For various clip spacings (i.e. span values)									
				Top in Compression			Bottom in Compression			Negative Load												
				I_{xx} in ⁴ /ft.	I_{xx} (eff) in ⁴ /ft.	S_{xx} in ³ /ft.	I_{xx} in ⁴ /ft.	I_{xx} (eff) in ⁴ /ft.	S_{xx} in ³ /ft.	1'	1.5'	2'	2.5'	3'	3.5'	4'	4.5'	5'				
12	24	50	1.3	0.0297	0.0323	0.0381	0.0387	0.0361	0.0528	175	159.4	143.8	128.1	112.5	96.9	81.3	65.6	50				
12	22	50	1.53	0.0385	0.0419	0.0512	0.0503	0.0469	0.0714	167.5	152.8	138.1	123.4	108.8	94.1	79.4	64.7	50				
12	20	33	1.87	0.0569	0.0614	0.0801	0.0723	0.0678	0.11	167.5	152.8	138.1	123.4	108.8	94.1	79.4	64.7	50				
12	18	33	2.43	0.083	0.0885	0.1227	0.1018	0.0963	0.1624	167.5	152.8	138.1	123.4	108.8	94.1	79.4	64.7	50				

POSITIVE LOAD

Width, in.	Gauge	Yield ksi	Weight psf	SECTION PROPERTIES									ALLOWABLE UNIFORM LOADS, psf For various clip spacings (i.e. span values)									
				Top in Compression			Bottom in Compression			Positive Load												
				I_{xx} in ⁴ /ft.	I_{xx} (eff) in ⁴ /ft.	S_{xx} in ³ /ft.	I_{xx} in ⁴ /ft.	I_{xx} (eff) in ⁴ /ft.	S_{xx} in ³ /ft.	1'	2'	3'	4'	5'	6'	7'	8'	9'	10'			
12	24	50	1.3	0.0297	0.0323	0.0381	0.0387	0.0361	0.0528	358.2	179.1	105.9	59.6	38.1	26.5	19.5	14.9	11.8				
12	22	50	1.53	0.0385	0.0419	0.0512	0.0503	0.0469	0.0714	388.2	194.1	129.4	80	51.2	35.5	26.1	20	15.8				
12	20	33	1.87	0.0569	0.0614	0.0801	0.0723	0.0678	0.11	386.4	193.2	128.8	83.4	53.4	37.1	27.2	20.9	16.5				
12	18	33	2.43	0.0830	0.0885	0.1227	0.1018	0.0963	0.1624	665.5	332.7	221.8	127.8	81.8	56.8	41.7	32	25.3				

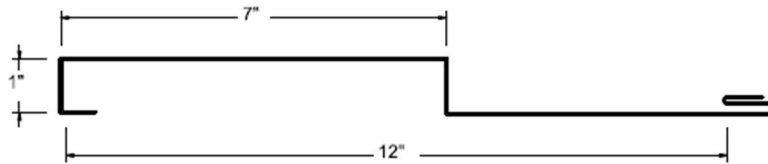

FIGURE 1-33 CR-B CLIP FLANGE PANELS

Contour CR-C Clip Flange

Panel profile and Fastening Schedule

All panels must be attached to support as described in Section 3.2 of the evaluation report using a minimum of two (2) #10 screws through the 18 ga. Standard Contour Clip. Fasteners must be placed inline with framing (perpendicular to the panel) .

NEGATIVE LOAD

Width, in.	Gauge	Yield ksi	Weight psf	SECTION PROPERTIES									ALLOWABLE UNIFORM LOADS, psf For various clip spacings (i.e. span values)									
				Top in Compression			Bottom in Compression			Negative Load												
				I_{xx} in ⁴ /ft.	I_{xx} (eff) in ⁴ /ft.	S_{xx} in ³ /ft.	I_{xx} in ⁴ /ft.	I_{xx} (eff) in ⁴ /ft.	S_{xx} in ³ /ft.	1'	1.5'	2'	2.5'	3'	3.5'	4'	4.5'	5'				
12	24	50	1.3	0.0284	0.0317	0.0378	0.04	0.0366	0.0531	137.5	123.4	109.4	95.3	81.3	67.2	53.2	39.1	25				
12	22	50	1.53	0.0369	0.0413	0.0508	0.0521	0.0477	0.0715	175	159.4	143.4	128.1	112.5	96.9	81.3	65.6	50				
12	20	33	1.87	0.0544	0.0604	0.0797	0.0752	0.0691	0.1098	175	159.4	143.4	128.1	112.5	96.9	81.3	65.6	50				
12	18	33	2.43	0.0791	0.0868	0.1224	0.1059	0.0981	0.1615	175	159.4	143.4	128.1	112.5	96.9	81.3	65.6	50				

POSITIVE LOAD

Width, in.	Gauge	Yield ksi	Weight psf	SECTION PROPERTIES									ALLOWABLE UNIFORM LOADS, psf For various clip spacings (i.e. span values)									
				Top in Compression			Bottom in Compression			Positive Load												
				I_{xx} in ⁴ /ft.	I_{xx} (eff) in ⁴ /ft.	S_{xx} in ³ /ft.	I_{xx} in ⁴ /ft.	I_{xx} (eff) in ⁴ /ft.	S_{xx} in ³ /ft.	1'	2'	3'	4'	5'	6'	7'	8'	9'	10'			
12	24	50	1.3	0.0284	0.0317	0.0378	0.04	0.0366	0.0531	358.2	179.1	105	59.1	37.8	26.3	19.3	14.8	11.7				
12	22	50	1.53	0.0369	0.0413	0.0508	0.0521	0.0477	0.0715	383.6	191.8	127.9	79.3	50.8	35.3	25.9	19.8	15.7				
12	20	33	1.87	0.0544	0.0604	0.0797	0.0752	0.0691	0.1098	386.4	193.2	128.8	83	53.1	36.9	27.1	20.8	16.4				
12	18	33	2.43	0.0791	0.0868	0.1224	0.1059	0.0981	0.1615	665.5	332.7	221.8	127.8	81.6	56.7	41.6	31.9	25.2				



FIGURE 1-34 CR-C CLIP FLANGE PANELS

Contour CR-D Clip Flange

Panel profile and Fastening Schedule

All panels must be attached to support as described in Section 3.2 of the evaluation report using a minimum of two (2) #10 screws through the 18 ga. Standard Contour Clip. Fasteners must be placed inline with framing (perpendicular to the panel).

NEGATIVE LOAD

				SECTION PROPERTIES						ALLOWABLE UNIFORM LOADS, psf For various clip spacings (i.e. span values)									
Width, in.	Gauge	Yield ksi	Weight psf	Top in Compression			Bottom in Compression			Negative Load									
				I_{xx} in ⁴ /ft.	I_{xx} (eff) in ⁴ /ft.	S_{xx} in ³ /ft.	I_{xx} in ⁴ /ft.	I_{xx} (eff) in ⁴ /ft.	S_{xx} in ³ /ft.	1'	1.5'	2'	2.5'	3'	3.5'	4'	4.5'	5'	
12	24	50	1.3	0.027	0.0311	0.0373	0.041	0.0369	0.053	187.5	171.9	156.3	140.6	125	109.9	93.8	78.1	62.5	
12	22	50	1.53	0.0348	0.0402	0.0501	0.0535	0.0481	0.0713	212.5	192.2	171.9	151.6	131.3	110.9	90.6	70.3	50	
12	20	33	1.87	0.0511	0.0586	0.0788	0.0771	0.0695	0.1088	212.5	192.2	171.9	151.6	131.3	110.9	90.6	70.3	50	
12	18	33	2.43	0.074	0.0838	0.1213	0.108	0.0981	0.1591	212.5	192.2	171.9	151.6	131.3	110.9	90.6	70.3	50	

POSITIVE LOAD

				SECTION PROPERTIES						ALLOWABLE UNIFORM LOADS, psf For various clip spacings (i.e. span values)									
Width, in.	Gauge	Yield ksi	Weight psf	Top in Compression			Bottom in Compression			Positive Load									
				I_{xx} in ⁴ /ft.	I_{xx} (eff) in ⁴ /ft.	S_{xx} in ³ /ft.	I_{xx} in ⁴ /ft.	I_{xx} (eff) in ⁴ /ft.	S_{xx} in ³ /ft.	1'	2'	3'	4'	5'	6'	7'	8'	9'	10'
12	24	50	1.3	0.027	0.0311	0.0373	0.041	0.0369	0.053	358.2	179.1	103.6	58.3	37.3	25.9	19	14.6	11.5	
12	22	50	1.53	0.0348	0.0402	0.0501	0.0535	0.0481	0.0713	383.6	191.8	127.9	78.3	50.1	34.8	25.6	19.6	15.5	12.5
12	20	33	1.87	0.0511	0.0586	0.0788	0.0771	0.0695	0.1088	386.4	193.2	128.8	82.1	52.5	36.5	26.8	20.5	16.2	13.1
12	18	33	2.43	0.074	0.0838	0.1213	0.108	0.0981	0.1591	665.5	332.7	221.8	126.4	80.9	56.2	41.3	31.6	25	20.2

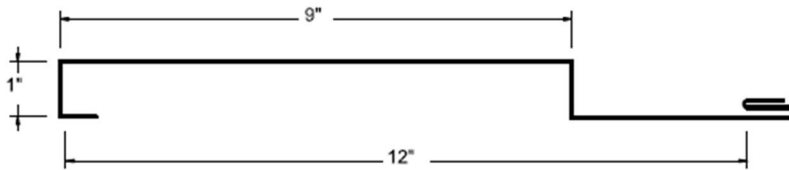

FIGURE 1-35 CR-D CLIP FLANGE PANELS

Contour CR-E Clip Flange

Panel profile and Fastening Schedule

All panels must be attached to support as described in Section 3.2 of the evaluation report using a minimum of two (2) #10 screws through the 18 ga. Standard Contour Clip. Fasteners must be placed inline with framing (perpendicular to the panel).

NEGATIVE LOAD

				SECTION PROPERTIES						ALLOWABLE UNIFORM LOADS, psf For various clip spacings (i.e. span values)							
Width, in.	Gauge	Yield ksi	Weight psf	Top in Compression			Bottom in Compression			Negative Load							
				I_{xx} in ⁴ /ft.	I_{xx} (eff) in ⁴ /ft.	S_{xx} in ³ /ft.	I_{xx} in ⁴ /ft.	I_{xx} (eff) in ⁴ /ft.	S_{xx} in ³ /ft.	1'	1.5'	2'	2.5'	3'	3.5'	4'	
12	24	50	1.30	0.0255	0.0324	0.0367	0.0495	0.0425	0.0658	200.0	175.8	151.6	127.5	103.3	79.1	55.0	
12	22	50	1.53	0.0325	0.0409	0.0479	0.0616	0.0531	0.0832	212.5	185.4	158.3	131.2	104.1	77.0	50.0	
12	20	33	1.87	0.0480	0.0588	0.0762	0.0851	0.0743	0.1199	212.5	185.4	158.3	131.2	104.1	77.0	50.0	
12	18	33	2.43	0.0700	0.0839	0.1183	0.1180	0.1041	0.1713	212.5	185.4	158.3	131.2	104.1	77.0	50.0	
12	0.032"	19	0.49	0.0940	0.0940	0.1413	0.0940	0.0940	0.2825	175.0	157.5	140.0	122.5	105.0	87.5	70.0	
12	0.040"	19	0.59	0.1160	0.1160	0.1741	0.1160	0.1160	0.3464	175.0	157.5	140.0	122.5	105.0	87.5	70.0	

POSITIVE LOAD

				SECTION PROPERTIES						ALLOWABLE UNIFORM LOADS, psf For various clip spacings (i.e. span values)									
Width, in.	Gauge	Yield ksi	Weight psf	Top in Compression			Bottom in Compression			Positive Load									
				I_{xx} in ⁴ /ft.	I_{xx} (eff) in ⁴ /ft.	S_{xx} in ³ /ft.	I_{xx} in ⁴ /ft.	I_{xx} (eff) in ⁴ /ft.	S_{xx} in ³ /ft.	1'	2'	3'	4'	5'	6'	7'	8'	9'	10'
12	24	50	1.40	0.0255	0.0324	0.0367	0.0495	0.0425	0.0658	358.2	179.1	101.9	57.3	36.7	25.5	18.7	14.3	11.3	
12	22	50	1.65	0.0325	0.0409	0.0479	0.0616	0.0531	0.0832	492.7	246.36	133.06	74.84	47.9	33.26	24.44	18.71	14.8	12.0
12	20	33	1.95	0.0480	0.0588	0.0762	0.0851	0.0743	0.1199	474.6	237.27	141.11	79.4	50.8	35.3	25.92	19.8	15.7	12.7
12	18	33	2.52	0.0700	0.0839	0.1183	0.1180	0.1041	0.1713	779.09	389.55	219.1	123.23	78.87	54.77	40.24	30.81	24.3	19.7
12	0.032"	19	0.49	0.0940	0.0940	0.1413	0.0940	0.0940	0.2825	55.5	27.7	18.5	13.9	11.1					
12	0.040"	19	0.59	0.1160	0.1160	0.1741	0.1160	0.1160		86.4	43.2	28.8	21.6	17.3	14.4	12.34	10.8		

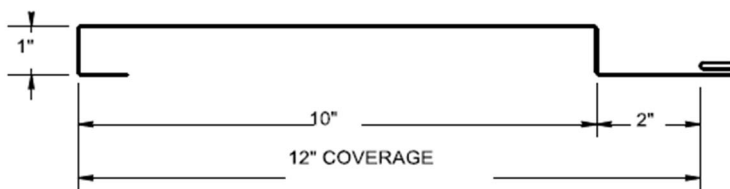

FIGURE 1-36 CR-E CLIP FLANGE PANELS

Contour CR-F Clip Flange

Panel profile and Fastening Schedule

All panels must be attached to support as described in Section 3.2 of the evaluation report using a minimum of two (2) #10 screws through the 18 ga. Standard Contour Clip. Fasteners must be placed inline with framing (perpendicular to the panel).

NEGATIVE LOAD				SECTION PROPERTIES									ALLOWABLE UNIFORM LOADS, psf For various clip spacings (i.e. span values)									
Width, in.	Gauge	Yield ksi	Weight psf	Top in Compression			Bottom in Compression			Negative Load												
				I_{xx} in ⁴ /ft.	I_{xx} (eff) in ⁴ /ft.	S_{xx} in ³ /ft.	I_{xx} in ⁴ /ft.	I_{xx} (eff) in ⁴ /ft.	S_{xx} in ³ /ft.	1'	1.5'	2'	2.5'	3'	3.5'	4'	4.5'	5'				
12	24	50	1.3	0.0226	0.0281	0.0354	0.0416	0.0303	0.0315	137.5	125	112.5	100	87.5	75	62.5	50	37.5				
12	22	50	1.53	0.0287	0.036	0.0474	0.0539	0.0466	0.0685	112.5	103.1	93.8	83.4	75	65.6	56.3	46.9	37.5				
12	20	33	1.87	0.0413	0.0513	0.075	0.0759	0.0659	0.1002	112.5	103.1	93.8	83.4	75	65.6	56.3	46.9	37.5				
12	18	33	2.43	0.059	0.0712	0.1157	0.101	0.0888	0.1362	112.5	103.1	93.8	83.4	75	65.6	56.3	46.9	37.5				

POSITIVE LOAD				SECTION PROPERTIES									ALLOWABLE UNIFORM LOADS, psf For various clip spacings (i.e. span values)										
Width, in.	Gauge	Yield ksi	Weight psf	Top in Compression			Bottom in Compression			Positive Load													
				I_{xx} in ⁴ /ft.	I_{xx} (eff) in ⁴ /ft.	S_{xx} in ³ /ft.	I_{xx} in ⁴ /ft.	I_{xx} (eff) in ⁴ /ft.	S_{xx} in ³ /ft.	1'	2'	3'	4'	5'	6'	7'	8'	9'	10'				
12	24	50	1.3	0.0226	0.0281	0.0354	0.0416	0.0303	0.0315	358.2	179.1	98.4	55.3	35.4	24.6	18.1	13.8	10.9	8.5				
12	22	50	1.53	0.0287	0.036	0.0474	0.0539	0.0466	0.0685	383.6	191.8	127.9	74.1	47.4	32.9	24.2	18.5	14.6	11.9				
12	20	33	1.87	0.0413	0.0513	0.075	0.0759	0.0659	0.1002	386.4	193.2	128.8	78.1	50	35.4	25.5	19.5	15.4	12.5				
12	18	33	2.43	0.059	0.0712	0.1157	0.101	0.0888	0.1362	665.5	332.7	214.3	120.5	77.1	53.6	39.4	30.1	23.8	19.3				

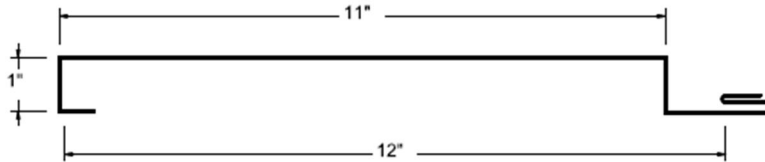

FIGURE 1-37 CR-F CLIP FLANGE PANELS

SmoothWall/Soffit Screw Flange

Panel profile and Fastening Schedule

Two (2) #10 screws fastened at each support and No. 14 screw at 24" on center at each panel vertical leg.

NEGATIVE LOAD				SECTION PROPERTIES									ALLOWABLE UNIFORM LOADS, psf For various fastener spacings (i.e. span)				
Width, in.	Gauge	Yield ksi	Weight psf	Top in Compression			Bottom in Compression			Negative Load							
				I_{xx} in ⁴ /ft.	I_{xx} (eff) in ⁴ /ft.	S_{xx} in ³ /ft.	I_{xx} in ⁴ /ft.	I_{xx} (eff) in ⁴ /ft.	S_{xx} in ³ /ft.	2'	2.5'	3'	3.5'	4'			
12-5/8"	24	50	1.31	0.0204	0.0241	0.0354	0.0332	0.0295	0.0388	62.1	59.6	57.1	54.6	52.1			
12	22	50	1.61	0.0279	0.0322	0.0507	0.0429	0.0385	0.0502	78.1	72.9	67.7	62.5	57.3			
12	20	33	1.86	0.0372	0.0418	0.0742	0.0531	0.0485	0.0633	78.1	72.9	67.7	62.5	57.3			
12	18	33	2.42	0.0540	0.0586	0.0957	0.0700	0.0653	0.0853	78.1	72.9	67.7	62.5	57.3			

POSITIVE LOAD				SECTION PROPERTIES									ALLOWABLE UNIFORM LOADS, psf For various fastener spacings (i.e. span values)										
Width, in.	Gauge	Yield ksi	Weight psf	Top in Compression			Bottom in Compression			Positive Load													
				I_{xx} in ⁴ /ft.	I_{xx} (eff) in ⁴ /ft.	S_{xx} in ³ /ft.	I_{xx} in ⁴ /ft.	I_{xx} (eff) in ⁴ /ft.	S_{xx} in ³ /ft.	1'	2'	3'	4'	5'	6'	7'	8'	9'	10'				
12-5/8"	24	50	1.89	0.0204	0.0241	0.0354	0.0332	0.0295	0.0388	263.6	131.8	87.9	55.3	35.4	24.6	18.1	13.8	10.9	8.5				
12	22	50	2.21	0.0279	0.0322	0.0507	0.0429	0.0385	0.0502	391.8	195.91	130.61	78.44	50.2	34.86	25.61	19.61	15.5	12.6				
12	20	33	2.69	0.0372	0.0418	0.0742	0.0531	0.0485	0.0633	400.9	200.45	117.22	65.9	42.2	29.3	21.53	16.5	13.0	10.6				
12	18	33	3.48	0.0540	0.0586	0.0957	0.0700	0.0653	0.0853	664.6	332.3	158.0	88.85	56.87	39.49	29.01	22.21	17.6	14.2				
12	0.032"	19	0.52	0.0640	0.0640	0.0310	0.0640	0.0640	0.0786	47.3	23.6	15.8	11.8										
12	0.040"	19	1.14	0.0790	0.0790	0.3788	0.0790	0.0790	0.0966	73.6	36.8	24.6	18.4	14.7	12.3	10.52							

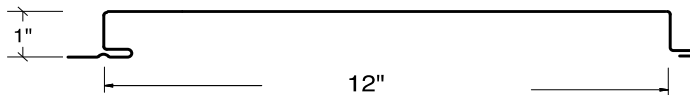

FIGURE 1-38 SMOOTHWALL/SOFFIT SCREW FLANGE PANELS

SmoothWall/Soffit with High Wind Clip
Panel profile and Fastening Schedule

Fasten High Wind Clips to the support structure with two (2) #14 screws in each end of the two slots. Fasten each panel screw flange to the High Wind Clip and into support structure with one (1) #10 screw.

NEGATIVE LOAD

				SECTION PROPERTIES						ALLOWABLE UNIFORM LOADS, psf				
				Top in Compression			Bottom in Compression			For various clip spacings (i.e. span values)				
Width, in.	Gauge	Yield ksi	Weight psf							Negative Load				
				I_{xx} in ⁴ /ft.	I_{xx} (eff) in ⁴ /ft.	S_{xx} in ³ /ft.	I_{xx} in ⁴ /ft.	I_{xx} (eff) in ⁴ /ft.	S_{xx} in ³ /ft.	2'	2.5'	3'	3.5'	4'
12	24	50	1.31	0.0204	0.0241	0.0354	0.0332	0.0295	0.0388	140.5	119.7	98.9	78.1	57.3
12	22	50	1.61	0.0279	0.0322	0.0507	0.0429	0.0385	0.0502	156.1	135.3	114.5	93.7	72.9
12	20	33	1.86	0.0372	0.0418	0.0742	0.0531	0.0485	0.0633	156.1	135.3	114.5	93.7	72.9
12	18	33	2.42	0.0540	0.0586	0.0957	0.0700	0.0653	0.0853	156.1	135.3	114.5	93.7	72.9
12	0.032"	19	0.53	0.0640	0.0640	0.0310	0.0640	0.0640	0.0786	98.9	83.2	67.6	52.0	36.4
12	0.040"	19	0.76	0.0790	0.0790	0.3788	0.0790	0.0790	0.0966	98.9	83.2	67.6	52.0	36.4

POSITIVE LOAD

				SECTION PROPERTIES						ALLOWABLE UNIFORM LOADS, psf									
				Top in Compression			Bottom in Compression			For various clip spacings (i.e. span values)									
Width, in.	Gauge	Yield ksi	Weight psf							Positive Load									
				I_{xx}	I_{xx} (eff)	S_{xx}	I_{xx}	I_{xx} (eff)	S_{xx}	1'	2'	3'	4'	5'	6'	7'	8'	9'	10'
12	24	50	1.89	0.0204	0.0241	0.0354	0.0332	0.0295	0.0388	263.6	131.8	87.9	55.3	35.4	24.6	18.1	13.8	10.9	12.6
12	22	50	2.21	0.0279	0.0322	0.0507	0.0429	0.0385	0.0502	391.8	195.91	130.61	78.44	50.2	34.86	25.61	19.61	15.5	12.6
12	20	33	2.69	0.0372	0.0418	0.0742	0.0531	0.0485	0.0633	400.9	200.45	117.22	65.9	42.2	29.3	21.53	16.5	13.0	10.6
12	18	33	3.48	0.0540	0.0586	0.0957	0.0700	0.0653	0.0853	664.6	332.3	158.0	88.85	56.87	39.49	29.01	22.21	17.6	14.2
12	0.032"	19	0.52	0.0640	0.0640	0.0310	0.0640	0.0640	0.0786	47.3	23.6	15.8	11.8						
12	0.040"	19	1.14	0.0790	0.0790	0.3788	0.0790	0.0790	0.0966	73.6	36.8	24.6	18.4	14.7	12.3	10.52			

HIGH WIND CLIP

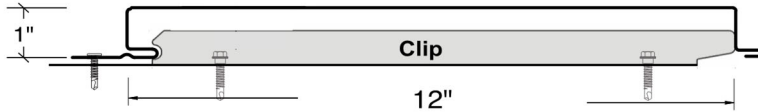

FIGURE 1-39 SMOOTHWALL/SOFFT WITH HIGH WIND CLIP PANELS



STANDARD CONTOUR CLIP

DIMENSIONS IN DECIMAL INCHES

TOLERANCE: ± .010

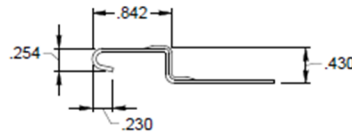
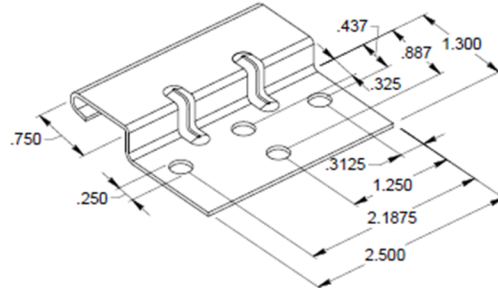

Manufactured for TMP by Clip Master



STANDARD CONTOUR EXPRESS CLIP

DIMENSIONS IN DECIMAL INCHES

TOLERANCE: ± .010

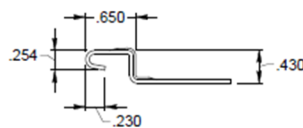
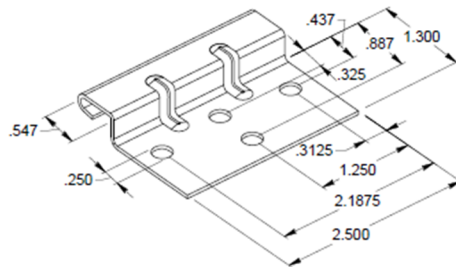

Manufactured for TMP by Clip Master

FIGURE 2- TMP CONTOUR SIDING CLIPS

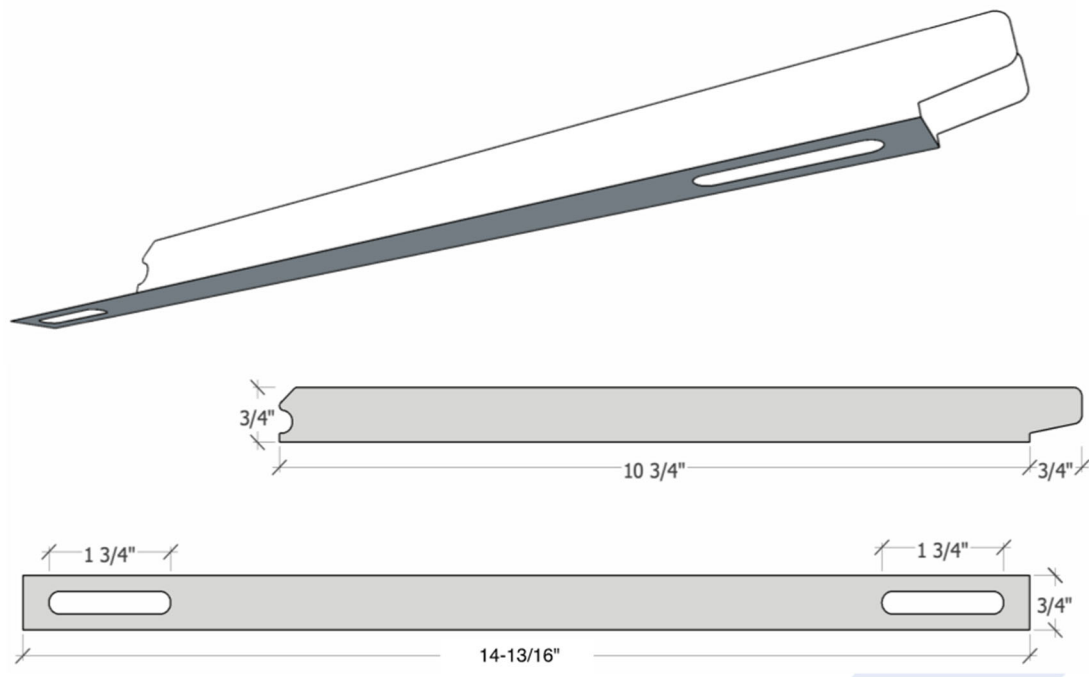

FIGURE 3- TMP SMOOTHWALL HIGH WIND CLIPS

DIVISION: 07 00 00—THERMAL AND MOISTURE PROTECTION**Section: 07 46 16—Aluminum Siding****Section: 07 46 19—Steel Siding****REPORT HOLDER:****TAYLOR METAL, INC. (dba TAYLOR METAL PRODUCTS)****EVALUATION SUBJECT:****TMP METAL SIDING****1.0 REPORT PURPOSE AND SCOPE****Purpose:**

The purpose of this evaluation report supplement is to indicate that TMP metal siding, described in ICC-ES evaluation report [ESR-5045](#), has also been evaluated for compliance with the codes noted below as adopted by the Los Angeles Department of Building and Safety (LADBS).

Applicable code editions:

- 2023 *City of Los Angeles Building Code* (LABC)
- 2023 *City of Los Angeles Residential Code* (LARC)

2.0 CONCLUSIONS

The TMP metal siding, described in Sections 2.0 through 7.0 of the evaluation report [ESR-5045](#), complies with the LABC Chapter 14, and the LARC, and is subject to the conditions of use described in this supplement.

3.0 CONDITIONS OF USE

The TMP metal siding described in this evaluation report supplement must comply with all of the following conditions:

- All applicable sections in the evaluation report [ESR-5045](#).
- The design, installation, conditions of use and identification of the TMP metal siding are in accordance with the 2021 *International Building Code*® (IBC) provisions noted in the evaluation report [ESR-5045](#).
- The design, installation and inspection are in accordance with additional requirements of LABC Chapters 14, 16 and 17, and LARC Section 703.3, as applicable.
- Under the LARC, an engineered design in accordance with LARC Section R301.1.3 must be submitted.

This supplement expires concurrently with the evaluation report, reissued April 2024.

DIVISION: 07 00 00—THERMAL AND MOISTURE PROTECTION**Section: 07 46 16—Aluminum Siding****Section: 07 46 19—Steel Siding****REPORT HOLDER:****TAYLOR METAL INC. (dba TAYLOR METAL PRODUCTS)****EVALUATION SUBJECT:****TMP METAL SIDING****1.0 REPORT PURPOSE AND SCOPE****Purpose:**

The purpose of this evaluation report supplement is to indicate that TMP metal siding, described in ICC-ES evaluation report ESR-5045, has also been evaluated for compliance with the codes noted below.

Applicable code edition(s):

- 2022 California Building Code (CBC)

For evaluation of applicable chapters adopted by the California Office of Statewide Health Planning and Development (OSHPD) AKA: California Department of Health Care Access and Information (HCAI) and the Division of State Architect (DSA), see Sections 2.1.1 and 2.1.2 below.

- 2022 California Residential Code (CRC)

2.0 CONCLUSIONS**2.1 CBC:**

The TMP metal siding, described in Sections 2.0 through 7.0 of the evaluation report ESR-5045, complies with CBC Chapter 14, provided the design and installation are in accordance with the 2021 *International Building Code*® (IBC) provisions noted in the evaluation report and the additional requirements of CBC Chapters 14, 16 and 17, as applicable.

2.1.1 OSHPD:

The TMP metal siding, described in Sections 2.0 through 7.0 of the evaluation report ESR-5045, complies with CBC Chapter 14 with applicable amendments [OSHPD 1, 1R, 3, 4 and 5], provided the design and installation are in accordance with the 2021 *International Building Code*® (IBC) provisions noted in the evaluation report and the additional requirements of CBC Chapters 16, 16A, 17 and 17A, as applicable.

2.1.2 DSA:

The TMP metal siding, described in Sections 2.0 through 7.0 of the evaluation report ESR-5045, complies with CBC Chapter 14 with applicable amendments [DSA-SS, DSA-SS/CC], provided the design and installation are in accordance with the 2021 *International Building Code*® (IBC) provisions noted in the evaluation report and the additional requirements of CBC Chapters 16, 16A, and 17A, as applicable.

2.2 CRC:

The TMP metal siding, described in Sections 2.0 through 7.0 of the evaluation report ESR-5045, complies with CRC Chapter 7, provided the design and installation are in accordance with the 2021 *International Residential Code*® (IRC) provisions noted in the evaluation report and the additional requirements of CRC Chapter 3 and 7, as applicable.

This supplement expires concurrently with the evaluation report, reissued April 2024.