

# UL Solutions Evaluation Report

## UL ER25913-01

Issued: March 31, 2016

Revised: October 20, 2023

Visit the UL Solutions [Product iQ® database](#) for current status of report.

UL Solutions Category Code: ULEZ

CSI MasterFormat®

DIVISION: 07 00 00 - THERMAL AND MOISTURE PROTECTION

Sublevel 2: 07 40 00 - Roofing and Siding Panels

Sublevel 3: 07 41 00 - Roof Panels

Sublevel 4: 07 41 13 – Metal Roof Panels

### COMPANY:

TAYLOR METAL INC, DBA TAYLOR METAL PRODUCTS

4566 RIDGE DRIVE NE

SALEM, OR 97301-6992

(503) 581-8338

[www.taylormetal.com](http://www.taylormetal.com)

### 1. SUBJECT:

EASY-LOCK, VERSA-SPAN, MS-100, MS-150, MS-200, PREMIER-LOCK-100, PREMIER-LOCK-150, CLIP-LOCK-150, T-PANEL NARROW BATTEN, PBR/MARION R, CLASSIC 7/8" CORRUGATED, HR-34, AND BR-36 METAL ROOFING PANELS



## 2. SCOPE OF EVALUATION

- 2021, 2018, 2015, and 2012 *International Building Code*® (IBC)
- 2021, 2018, 2015, and 2012 *International Residential Code*® (IRC)
- 2019, 2016, and 2013 California Building Code
- 2019, 2016, and 2013 California Residential Code
- ICC-ES Acceptance Criteria for Quality Documentation (AC10)
- ICC-ES Acceptance Criteria for Metal Roof Coverings (AC166)

### The products underwent evaluation for the following properties:

- Roofing Systems for Exterior Fire Exposure (UL790, ASTM E108)
- Wind Uplift Resistance for Roof Assemblies (UL 580, ASTM E1592, FM 4471)
- Impact Resistance of Roofing Systems (UL 2218A)
- Corrosion Resistance (ASTM A653, ASTM A792)
- Corrosion Resistance (ASTM B370)

## 3. REFERENCED DOCUMENTS

- ICC-ES:
  - ICC-ES Acceptance Criteria for Metal Roof Coverings (AC166)
  - ICC-ES Acceptance Criteria for Quality Documentation (AC10)
- UL:
  - UL 580 Standard for Tests for Uplift Resistance of Roof Assemblies
  - UL 790 (ASTM E108) Standard Test Methods for Fire Tests of Roof Coverings
  - UL 2218A Impact Resistance of Roofing Systems
- AISI:
  - AISI S100, North American Specification for the Design of Cold-Formed Steel Structural Members
- ASTM:
  - ASTM A653/A653M, Standard Specification for Steel Sheet, Zinc-Coated (Galvanized) or Zinc-Iron Alloy-Coated (Galvannealed) by the Hot-Dip Process
  - ASTM A792/A792M, Standard Specification for Steel Sheet, 55% Aluminum-Zinc Alloy-Coated by the Hot-Dip Process
  - ASTM B370, Standard Specification for Copper Sheet and Strip for Building Construction
  - ASTM E1592, Standard Test Method for Structural Performance of Sheet Metal Roof and Siding Systems by Uniform Static Air Pressure Difference
  - ASTM G154, Practice for Operating Xenon Arc Light Apparatus for Exposure of Nonmetallic Materials
- Factory Mutual Approvals:
  - FM 4471, Approval Standard for Class 1 Panel Roofs

## 4. USES

Easy-Lock, MS-200, Versa-Span, MS-100, MS-150, Premier-Lock 100, Premier-Lock-150, Clip-Lock-150, T-Panel Narrow Batten, PBR/Marion R, Classic 7/8" Corrugated, HR-34, and BR-36 metal roofing panels are used as roof covering materials in Class A roofing systems installed on roof decks and spaced supports having slopes 1/2:12 or greater, in accordance with this report, and the manufacturer's published installation instructions.

## 5. PRODUCT DESCRIPTION

### 5.1 General:

Taylor Metal Products' metal roofing panels described in this report are either coated or painted metal formed from ASTM A653 G90, ASTM A792 AZ50 hot-dip coated sheet steel, or from ASTM B370 cold-rolled copper sheet.

Steel Easy-Lock panels are manufactured to have a base metal thickness not less than 26 gauge [0.0179 in. (0.455 mm)]. Steel MS-100, MS-150, MS-200, Versa-Span, Premier-Lock 100, Premier-Lock-150, Clip-Lock-150, T-Panel Narrow Batten, PBR/Marion R, Classic  $\frac{7}{8}$ " Corrugated, HR-34, and BR-36 panels are manufactured to have a base metal thickness not less than 25 gauge [0.0209 in. (0.531 mm)]. Copper Easy-Lock, MS-100, MS-150, MS-200, Versa Span, Premier-Lock 100, Premier-Lock 150, and Clip-Lock 150 panels are manufactured to a finished weight not less than 16 ounces per square foot having a thickness of [0.0216 in. (0.549 mm)], with the allowable tolerances.

The panels are metal roof coverings complying with Section 1507.4 of the IBC and California Building Code and Section R905.10 of the IRC and California Residential Code.

**5.2 Fire Certification:** Taylor Metal Products' metal roofing panels covered under this report are UL Classified for Class A fire performance in accordance with UL790 (ASTM E108), which qualifies them for use under Section 1505.1 of the IBC, and Section R902.1 of the IRC and California Residential Code. Refer to Table 1, Table 2, Table 3, and Table 4.

See the Listing under TGFU.R25913 which includes T-3, Tuff-Rib, PBR/Marion R, Classic  $\frac{7}{8}$ " Corrugated, HR-34, and BR-36 profiles.

**5.3 Wind Resistance:** Roofing assemblies shall be designed to resist the design wind load pressures for components and cladding in accordance with Section 1609.5 and Section 1507.4 of the IBC, the California Building Code, and Section R905.10 of the IRC and California Residential Code.

**5.4 Wind Uplift Resistance:** Taylor Metal Products' metal roofing panels covered under this report have been tested for wind uplift resistance in accordance with UL 580 or ASTM E1592 complying with Section 1504.4 of the 2021 IBC, and Section 1504.3 of the 2018, 2015, and 2012 IBC and the California Building Code. Refer to Tables 1 through 6.

**5.5 Wind-Driven Rain Resistance:** The metal roofing panels covered under this report are not intended for installation in High-Velocity Hurricane Zones. Therefore, the wind-driven rain test specified in AC166 was not conducted under this evaluation report.

**5.6 Corrosion Resistance:** Taylor metal roofing panels covered under this report comply with the material properties and performance requirements for metal panel roof coverings as outlined in Section 1507.4.3 of the IBC and California Building Code, Section 905.10.3 of the IRC and California Residential Code, and meet the requirements for resistance to corrosion in accordance with ASTM A792.

## 6. INSTALLATION

### 6.1 General:

Taylor metal roofing panels must be installed in accordance with Section 1507.4 of the IBC, the California Building Code, Section R905.10 of the IRC and California Residential Code, except as noted in this report and the manufacturer's published installation instructions. The manufacturer's published installation instructions must be available at all times on the jobsite during installation. The metal roofing panels must be attached to the decked sheathing in a manner that will secure the panels in place.

**6.2 Slope:** MS-100, MS-150, , BR-36, Classic Corrugated, HR-34, and PBR/Marion R metal roofing panels are not to be installed on roof decks having slopes less than 1:12. MS-200 metal roofing panels are not to be installed on roof decks having slopes less than  $\frac{1}{2}$ :12. Versa-Span metal roofing panels are not to be installed on roof decks having slopes less than 2:12. All other products covered in this report are intended for roof decks having 3:12 slope or greater.

Installation of Taylor metal roofing panels covered in this report are to be installed in accordance with Section 507.4.2 of the IBC and the California Building Code, or Section R905.10.2 of the IRC and the 2019 California Residential Code.

**6.3 Roof Deck:** Roof decking is to be as described in Section 1507.4.1 of the IBC and the 2019 California Building Code, Section R905.10.1 of the IRC and the California Residential Code. Roof deck must be code-compliant, minimum nominal ½ inch-thick (11.9 mm) exterior sheathing complying with Section 2304.8.2 of the 2021 and 2018 IBC, Section 2304.7.2 of the 2015 and 2012 IBC and 2019 California Building Code, or Section R803 of the IRC and the 2019 California Residential Code, or minimum No. 22 gauge [0.030 inch thick (0.76 mm)] steel complying with Section 2210.1.1.2 of the IBC and the California Building Code. The sheathing must be structurally sound and adequately fastened to resist wind loads for components and cladding as specified in Section 1609 of the IBC, the California Building Code, or Section R301.6 of the IRC and the California Residential Code.

**6.4 Underlayment:** An ice barrier must be installed along the eaves in locations historically prone to ice in accordance with Section 1507.7.4 of the IBC and the California Building Code, the 2019 California Residential Code, or Section R905.5.3.1 of the IRC. In addition to the ice barrier, an underlayment must be installed over the entire roof deck in accordance with Section 1507.1.1 of the IBC, the California Building Code, and Section R905.6.3 of the IRC and California Residential Code.

Underlayments installed on roofs in locations prone to high winds must be installed in accordance with Section 1507.4.5 of the IBC and the 2019 California Building Code, or Section R905.6.3 of the IRC and the 2019 California Residential Code.

**6.5 Flashing and Coping:** Flashing materials are to be installed in accordance with Section 1503.2 of the IBC and California Building Code and Section R903.2 IRC and the California Residential Code, as applicable.

Coping materials are to be installed in accordance with Section 1503.3 of the and California Building Code and Section R903.3 of the IRC and California Residential Code, as applicable.

**6.6 Hips and Ridges:** Hips and ridges must be installed in accordance with Taylor Metal, Inc.'s published installation instructions for exposure dimension and fastener type.

**6.7 Fasteners and Attachment:** Attachment of the roof panels must be in accordance with Section 1507.4.4 of the IBC and the California Building Code. Cold-formed steel used as the substrate for the attachment of the metal panels covered in this report must be identified in accordance with AISI S100.

**6.8 Reroofing:** Existing roof covering materials detrimental to performance of the roofing assembly are to be completely removed and replaced prior to installation of the Taylor metal roofing panels. Installation is to be performed for new construction as described in Section 6 of this report.

The existing roof shall be inspected in accordance with the provisions and limitations of Section 1512 of the 2021 IBC, Section 1511 of the 2018 and 2015 IBC and 2019 California Building Code, Section 1510 of the 2012, and Section R908 of the 2021, 2018, and 2015 IRC and California Residential Code, or Section R907 of the 2012 IRC, as applicable. Prior to the reroofing, hip and ridge coverings must be removed.

Flashing and edging must comply with Section 6.6 of this report and with Section 1512.6 of the 2021 IBC, Section 1511.6 of the 2018 and 2015 IBC, Sections 1510.5 and 1510.6 of the 2012 IBC and 2019 California Building Code, and Section R908.6 of the 2021, 2018, and 2015 IRC, and Section R907.6 of the 2012 IRC, and California Residential Code, as applicable.

Taylor Metal Products' (TMP) metal roof panels may be installed over existing Class A asphalt glass fiber mat shingles or any Class A UL Listed roof system as described in the UL Certification Category for Prepared Roof-covering Materials, Formed or Molded Metal, Fiber-Cement, Plastic or Fire-retardant-treated Wood (TFXX), for applicable coverage and details of the roof assembly.

## 7. CONDITIONS OF USE

### 7.1 General:

The metal roofing panels described in this report comply with or are suitable alternatives to what is specified in those codes listed in Section 2 of this report, subject to the following conditions:

- 7.2 Materials and methods of installation must comply with this report and the manufacturer's published installation instructions. In the event of a conflict between the installation instructions and this report, this report governs.
- 7.3 Only TMP specified fasteners shall be used in the installation of the roof covering system.
- 7.4 See UL's Product iQ™ for products evaluated for uplift resistance in accordance with UL 580, Tests For Uplift Resistance of Roof Assemblies in Metal Roof Deck Panels ([TJPV](#)), UL 790, Tests for Fire Resistance of Roof Covering Materials in Roofing Systems, ([TGFU](#)), and UL 2218, Impact Resistance of Prepared Roof-covering Materials in Roof-covering Materials, Impact Resistance ([TGAM](#)), respectively.
- 7.5 Wind uplift pressures on any roof area, including edges and corner zones shall not exceed the allowable wind pressure for the roof covering installed in that particular area. The allowable wind uplift pressure for the roof assembly shall be based on a minimum factor of safety of 2.0. The allowable wind uplift pressure is for the roof system only. The deck and framing to which the roofing system is attached shall be designed for the applicable components and cladding wind loads in accordance with the applicable code.
- 7.6 The metal roofing panels covered under this report are manufactured by Taylor Metal Products, located at the manufacturing locations named below, under the UL LLC Classification and Follow-Up Service Program, which includes inspections in accordance with the quality elements of ICC-ES Acceptance Criteria for Quality Documentation, AC 10.

Location	Plant ID (if applicable)
Salem, OR	N/A
McClellan CA	N/A

## 8. SUPPORTING EVIDENCE

- 8.1 Data in accordance with ICC-ES Acceptance Criteria for Metal Roof Coverings (AC166).
- 8.2 Manufacturer's descriptive product literature, including installation instructions.
- 8.3 UL Certification reports in accordance with UL 580, UL 790, and UL 2218A. See UL Product Certification Categories (TJPV), (TGFU), and (TGAM), File R25913.
- 8.4 Documentation of quality system elements described in ICC-ES Acceptance Criteria for Quality Documentation (AC10).

## 9. IDENTIFICATION

The metal roofing panels described in this evaluation report are identified by a marking bearing the report holder's name, Taylor Metal Products; the plant identification; the UL Solutions Classification Mark; and the evaluation report number UL Solutions 25913-01. The validity of the evaluation report is contingent upon this identification appearing on the product or UL Solutions Classification Mark certificate.

## **10. USE OF UL SOLUTIONS EVALUATION REPORT**

- 10.1** The approval of building products, materials or systems is under the responsibility of the applicable code authorities.
- 10.2** UL Solutions Evaluation Reports shall not be used in any manner that implies an endorsement of the product, material or system by UL Solutions.
- 10.3** The current status of this report, as well as a complete directory of UL Solutions Evaluation Reports, may be found at [UL.com/Solutions](http://UL.com/Solutions) via Product iQ®.

### [UL Solutions Evaluation Reports](#)

**TABLE 1: WIND UPLIFT ASSEMBLIES<sup>1</sup>**

System Number	Combustible Deck		Barrier Product	Metal Panel <sup>4</sup> Attachment	Allowable Uplift Pressure UL 580
	Wood Sheathing <sup>2</sup>	Attachment <sup>3</sup>			
<b>Minimum 29 Gauge Steel Easy-Lock<sup>5</sup>, Maximum 18 inches wide</b>					<b>Class 90</b>
<b>1</b>	Minimum nominal $\frac{5}{8}$ inch APA Span-Rated plywood	Minimum #6 x 1- $\frac{7}{8}$ inch bugle head screws or #8d annular ring shank nails spaced 6 inches oc at board edge and 12 inches oc into framing members	Georgia Pacific $\frac{1}{4}$ inch minimum DensDeck board or $\frac{1}{4}$ inch minimum United States Gypsum Co SECUROCK Glass-Mat Roof Board (Type SGMRX), National Gypsum DEXcell Glass Mat Roof Board or DEXcell FV Glass Mat Roof Board, CertainTeed Gypsum GlasRoc or $\frac{1}{2}$ inch minimum UL Certified gypsum board with all joints staggered a minimum of 6 inches from the plywood joints, or one layer Versashield® SOLO™ Fire Resistant Slip Sheet	(1) Minimum No. 10 x 1 inch pancake head screws spaced 12 inches oc in slotted fastener flange	<b>-52.5</b>
<b>Minimum 24 Gauge Steel Easy-Lock<sup>5</sup>, Maximum 18 inches wide</b>					<b>Class 90</b>
<b>2</b>	Minimum $\frac{19}{32}$ inch APA Span-Rated plywood	#6 x 1- $\frac{7}{8}$ inch bugle head screws or #8d annular ring shank nails spaced 6 inches oc at board edge and 12 inches oc into framing members <sup>5</sup>	Georgia Pacific $\frac{1}{4}$ inch minimum DensDeck board or $\frac{1}{4}$ inch minimum United States Gypsum Co SECUROCK Glass-Mat Roof Board (Type SGMRX), National Gypsum DEXcell Glass Mat Roof Board or DEXcell FV Glass Mat Roof Board, CertainTeed Gypsum GlasRoc or $\frac{1}{2}$ inch minimum UL Certified gypsum board with all joints staggered a minimum of 6 inches from the plywood joints, or one layer Versashield® SOLO™ Fire Resistant Slip Sheet	(2) Minimum No. 10-12 x 1 inch pancake head screws spaced 36 inches oc	<b>-52.5</b>

<sup>1</sup>These assemblies comply with UL790 (ASTM E108) for Class A fire performance at an unlimited slope

<sup>2</sup>All side and butt joints to be sealed with urethane caulk

<sup>3</sup>Structural members spaced maximum 24 inches oc

<sup>4</sup>Any UL Certified Type G1, G2 or G3 base or ply sheet, Type 15 or 30 felt or Prepared Roofing Accessory may be used directly below the metal roof cover<sup>5</sup>Classified as Class 4 Impact

**TABLE 1: WIND UPLIFT ASSEMBLIES<sup>1</sup> (continued)**

System Number	Combustible Deck		Barrier Product	Metal Panel <sup>4</sup> Attachment	Allowable Uplift Pressure UL 580
	Wood Sheathing <sup>2</sup>	Attachment <sup>3</sup>			
<b>Minimum 24 Gauge Steel Versa Span<sup>5</sup>, Maximum 18 inches wide</b>					<b>Class 90</b>
<b>3</b>	Minimum <sup>19</sup> / <sub>32</sub> inch APA Span-Rated plywood	Minimum #6 x 1- <sup>7</sup> / <sub>8</sub> inch bugle head screws or #8d annular ring shank nails spaced 6 inches oc at board edge and 12 inches oc into framing members	Georgia Pacific ¼ inch minimum DensDeck board or ¼ inch minimum United States Gypsum Co SECUROCK Glass-Mat Roof Board (Type SGMRX), National Gypsum DEXcell Glass Mat Roof Board or DEXcell FV Glass Mat Roof Board, CertainTeed Gypsum GlasRoc or ½ inch minimum UL Certified gypsum board with all joints staggered a minimum of 6 inches from the plywood joints, or one layer Versashield® SOLO™ Fire Resistant Slip Sheet	(2) Minimum No. 10-12 x 1 inch pancake head screws spaced 36 inches oc	<b>-52.5</b>
<b>4</b>				(2) Minimum No. 10-12 x 1 inch pancake head screws spaced 36 inches oc	<b>-52.5</b>

<sup>1</sup>These assemblies comply with UL790 (ASTM E108) for Class A fire performance at an unlimited slope

<sup>2</sup>All side and butt joints to be sealed with urethane caulk

<sup>3</sup>Structural members spaced maximum 24 inches oc

<sup>4</sup>Any UL Certified Type G1, G2 or G3 base or ply sheet, Type 15 or 30 felt or Prepared Roofing Accessory may be used directly below the metal roof cover

<sup>5</sup>Meets Class 4 Impact Rating



**TABLE 1: WIND UPLIFT ASSEMBLIES<sup>1</sup> (continued)**

System Number	Combustible Deck		Barrier Product	Metal Panel <sup>4</sup> Attachment	Allowable Uplift Pressure UL 580
	Wood Sheathing <sup>2</sup>	Attachment <sup>3</sup>			
<b>Minimum .032 Aluminum Versa Span<sup>5</sup>, Maximum 16 inches wide</b>					<b>Class 90</b>
<b>5</b>	Minimum <sup>19</sup> / <sub>32</sub> inch APA Span-Rated plywood	No. 8 x 1- <sup>7</sup> / <sub>8</sub> inch bugle head screws or #8d annular ring shank nails spaced 6 inches oc at board edge and 12 inches oc into framing members	Georgia Pacific ¼ inch minimum DensDeck board or ¼ inch minimum United States Gypsum Co SECUROCK Glass-Mat Roof Board (Type SGMRX), National Gypsum DEXcell Glass Mat Roof Board or DEXcell FV Glass Mat Roof Board, CertainTeed Gypsum GlasRoc or ½ inch minimum UL Certified gypsum board with all joints staggered a minimum of 6 inches from the plywood joints, or one layer GAF VersaShield Solo Underlayment or Polyglass USA Inc Polystick XFR Underlayment	(2) Minimum No. 10-12 pancake head screws spaced 18 inches oc	<b>-52.5</b>
<b>Minimum 24 Gauge Steel T-Panel Narrow Batten<sup>5</sup>, Maximum 21-¼ inches wide</b>					<b>Class 90</b>
<b>6</b>	Minimum <sup>19</sup> / <sub>32</sub> inch APA Span-Rated plywood	No. 8 x 1- <sup>7</sup> / <sub>8</sub> inch bugle head screws or #8d annular ring shank nails spaced 6 inches oc at board edge and 12 inches oc into framing members	Georgia Pacific ¼ inch min DensDeck board or ¼ inch min United States Gypsum Co SECUROCK Glass-Mat Roof Board (Type SGMRX), National Gypsum DEXcell Glass Mat Roof Board or DEXcell FV Glass Mat Roof Board, CertainTeed Gypsum GlasRoc or ½ inch min UL Certified gypsum board with all joints staggered a min of 6 in. from the plywood joints, or one layer Versashield® SOLO™ Fire Resistant Slip Sheet	(2) Minimum No. 10-12 x 1 inch pancake head screws spaced 36 inches oc	<b>-52.5</b>

<sup>1</sup>These assemblies comply with UL790 (ASTM E108) for Class A fire performance at an unlimited slope

<sup>2</sup>All side and butt joints to be sealed with urethane caulk

<sup>3</sup>Structural members spaced maximum 24 inches oc

<sup>4</sup>Any UL Certified Type G1, G2 or G3 base or ply sheet, Type 15 or 30 felt or Prepared Roofing Accessory may be used directly below the metal roof cover

<sup>5</sup>Meets Class 4 Impact Rating

**TABLE 1: WIND UPLIFT ASSEMBLIES<sup>1</sup> (continued)**

System Number	Combustible Deck		Barrier Product	Metal Panel <sup>4</sup> Attachment	Allowable Uplift Pressure UL 580
	Wood Sheathing <sup>2</sup>	Attachment <sup>3</sup>			
<b>Minimum 24 Gauge Steel T-Panel Narrow Batten<sup>5</sup>, Maximum 21-1/4 inches wide</b>					<b>Class 90</b>
<b>7</b>	Minimum <sup>19</sup> / <sub>32</sub> inch APA Span-Rated plywood	No. 8 x 1-7/8 inch bugle head screws or #8d annular ring shank nails spaced 6 inches oc at board edge and 12 inches oc into framing members	Georgia Pacific 1/4 inch min DensDeck board or 1/4 inch min United States Gypsum Co SECUROCK Glass-Mat Roof Board (Type SGMRX), National Gypsum DEXcell Glass Mat Roof Board or DEXcell FV Glass Mat Roof Board, CertainTeed Gypsum GlasRoc or 1/2 inch min UL Certified gypsum board with all joints staggered a min of 6 in. from the plywood joints, or one layer Versashield® SOLO™ Fire Resistant Slip Sheet	(1) Minimum No. 10-12 x 1 inch pancake head screws spaced 24 inches oc	<b>-52.5</b>
<b>Minimum 24 Gauge Steel T-Panel Narrow Batten<sup>5</sup>, Maximum 20 inches wide</b>					<b>Class 90</b>
<b>8</b>	Minimum <sup>19</sup> / <sub>32</sub> inch APA Span-Rated plywood	No. 8 x 1-7/8 inch bugle head screws or #8d annular ring shank nails spaced 6 inches oc at board edge and 12 inches oc into framing members	Georgia Pacific 1/4 inch minimum DensDeck board or 1/4 inch minimum United States Gypsum Co SECUROCK Glass-Mat Roof Board (Type SGMRX), National Gypsum DEXcell Glass Mat Roof Board or DEXcell FV Glass Mat Roof Board, CertainTeed Gypsum GlasRoc or 1/2 inch minimum UL Certified gypsum board with all joints staggered a minimum of 6 inches from the plywood joints, or one layer Versashield® SOLO™ Fire Resistant Slip Sheet	(2) Minimum No. 10-12 pancake head screws spaced 18 inches oc	<b>-52.5</b>

<sup>1</sup>These assemblies comply with UL790 (ASTM E108) for Class A fire performance at an unlimited slope

<sup>2</sup>All side and butt joints to be sealed with urethane caulk

<sup>3</sup>Structural members spaced maximum 24 inches oc

<sup>4</sup>Any UL Certified Type G1, G2 or G3 base or ply sheet, Type 15 or 30 felt or Prepared Roofing Accessory may be used directly below the metal roof cover

<sup>5</sup>Meets Class 4 Impact Rating

**TABLE 1: WIND UPLIFT ASSEMBLIES<sup>1</sup> (continued)**

System Number	Combustible Deck		Barrier Product	Metal Panel <sup>4</sup> Attachment	Allowable Uplift Pressure UL 580
	Wood Sheathing <sup>2</sup>	Attachment <sup>3</sup>			
<b>16 Oz. Copper MS-100<sup>5</sup>, Maximum 17 inches wide</b>					<b>Class 90</b>
<b>9</b>	Minimum <sup>19</sup> / <sub>32</sub> inch APA Span-Rated plywood	#6 x 1- <sup>7</sup> / <sub>8</sub> inch bugle head screws or #8d annular ring shank nails spaced 6 inches oc at board edge and 12 inches oc into framing members	Georgia Pacific <sup>1</sup> / <sub>4</sub> inch minimum DensDeck board or <sup>1</sup> / <sub>4</sub> inch minimum United States Gypsum Co SECUROCK Glass-Mat Roof Board (Type SGMRX), National Gypsum DEXcell Glass Mat Roof Board or DEXcell FV Glass Mat Roof Board, CertainTeed Gypsum GlasRoc or <sup>1</sup> / <sub>2</sub> inch minimum UL Certified gypsum board with all joints staggered a minimum of 6 inches from the plywood joints, or one layer GAF VersaShield Solo Underlayment or Polyglass USA Inc Polystick XFR Underlayment	(2) Minimum No. 10-12 x 1 inch pancake head screws spaced 18	<b>-52.5</b>
<b>Minimum 24 Gauge Steel MS-100<sup>5</sup>, Maximum 18 inches wide</b>					<b>Class 90</b>
<b>10</b>	Minimum nominal <sup>5</sup> / <sub>8</sub> inch APA Span-Rated plywood	No. 8 x 2- <sup>1</sup> / <sub>2</sub> inch bugle head screws or #8d annular ring shank nails spaced 6 inches oc at board edge and 12 inches oc into framing members	Georgia Pacific <sup>1</sup> / <sub>4</sub> inch minimum DensDeck board or <sup>1</sup> / <sub>4</sub> inch minimum United States Gypsum Co SECUROCK Glass-Mat Roof Board (Type SGMRX), National Gypsum DEXcell Glass Mat Roof Board or DEXcell FV Glass Mat Roof Board, CertainTeed Gypsum GlasRoc or <sup>1</sup> / <sub>2</sub> inch minimum UL Certified gypsum board with all joints staggered a minimum of 6 inches from the plywood joints, or one layer Versashield® SOLO™ Fire Resistant Slip Sheet	(2) Minimum No. 10-12 x 1 inch pancake head screws spaced 24	<b>-52.5</b>

<sup>1</sup>These assemblies comply with UL790 (ASTM E108) for Class A fire performance at an unlimited slope

<sup>2</sup>All side and butt joints to be sealed with urethane caulk

<sup>3</sup>Structural members spaced maximum 24 inches oc

<sup>4</sup>Any UL Certified Type G1, G2 or G3 base or ply sheet, Type 15 or 30 felt or Prepared Roofing Accessory may be used directly below the metal roof cover

<sup>5</sup>Meets Class 4 Impact Rating

**TABLE 1: WIND UPLIFT ASSEMBLIES<sup>1</sup> (continued)**

System Number	Combustible Deck		Barrier Product	Metal Panel <sup>4</sup> Attachment	Allowable Uplift Pressure UL 580
	Wood Sheathing <sup>2</sup>	Attachment <sup>3</sup>			
<b>Minimum 24 Gauge Steel MS-150<sup>5</sup>, Maximum 16 inches wide</b>					<b>Class 90</b>
<b>11</b>	Minimum nominal 1/2 inch APA Span-Rated plywood	#7-6 x 1-5/8 inch bugle head screws or #8d annular ring shank nails spaced 6 inches oc at board edge and 12 inches oc into framing members <sup>5</sup>	Georgia Pacific 1/4 inch minimum DensDeck board or 1/4 inch minimum United States Gypsum Co SECUROCK Glass-Mat Roof Board (Type SGMRX), National Gypsum DEXcell Glass Mat Roof Board or DEXcell FV Glass Mat Roof Board, CertainTeed Gypsum GlasRoc or 1/2 inch minimum UL Certified gypsum board with all joints staggered a min of 6 in. from the plywood joints, or one layer GAF VersaShield Underlayment or Polyglass USA Inc Polystick XFR Underlayment	(4) Minimum No. 10-12 x 1 inch pancake head screws spaced 48 inches oc	<b>-52.5</b>
<b>12</b>	Minimum nominal 5/8 inch APA Span-Rated plywood	No. 8 x 2-1/2 inch bugle head screws spaced 6 inches oc at board edge and 12 inches oc into framing members	Georgia Pacific 1/4 inch minimum DensDeck board or 1/4 inch minimum United States Gypsum Co SECUROCK Glass-Mat Roof Board (Type SGMRX), National Gypsum DEXcell Glass Mat Roof Board or DEXcell FV Glass Mat Roof Board, CertainTeed Gypsum GlasRoc or 1/2 inch minimum UL Certified gypsum board with all joints staggered a min of 6 in. from the plywood joints, or one layer GAF VersaShield Underlayment or Polyglass USA Inc Polystick XFR Underlayment	(2) Minimum 1/4-13 x 1-5/8 inch truss head screws spaced 36 inches oc	<b>-52.5</b>

<sup>1</sup>These assemblies comply with UL790 (ASTM E108) for Class A fire performance at an unlimited slope

<sup>2</sup>All side and butt joints to be sealed with urethane caulk

<sup>3</sup>Structural members spaced maximum 24 inches oc

<sup>4</sup>Any UL Certified Type G1, G2 or G3 base or ply sheet, Type 15 or 30 felt or Prepared Roofing Accessory may be used directly below the metal roof cover

<sup>5</sup>Meets Class 4 Impact Rating

**TABLE 1: WIND UPLIFT ASSEMBLIES<sup>1</sup> (continued)**

System Number	Combustible Deck		Barrier Product	Metal Panel <sup>4</sup> Attachment	Allowable Uplift Pressure UL 580
	Wood Sheathing <sup>2</sup>	Attachment <sup>3</sup>			
<b>Minimum .032 Aluminum MS-150<sup>5</sup>, Maximum 20 inches wide</b>					<b>Class 90</b>
<b>13</b>	Minimum nominal 5/8 inch APA Span-Rated plywood	No. 8 x 2-1/2 inch bugle head screws spaced 6 inches oc at board edge and 12 inches oc into framing members	Georgia Pacific 1/4 inch minimum DensDeck board or 1/4 inch minimum United States Gypsum Co SECUROCK Glass-Mat Roof Board (Type SGMRX), National Gypsum DEXcell Glass Mat Roof Board or DEXcell FV Glass Mat Roof Board, CertainTeed Gypsum GlasRoc or 1/2 inch minimum UL Certified gypsum board with all joints staggered a minimum of 6 inches from the plywood joints, or one layer GAF VersaShield Solo Underlayment or Polyglass USA Inc Polystick XFR Underlayment	(2) Minimum 1/4-13 x 1-5/8 inch truss head screws spaced 36 inches oc	<b>-52.5</b>
<b>Minimum .032 Zinc MS-150<sup>5</sup>, Maximum 16 inches wide</b>					<b>Class 90</b>
<b>14</b>	Minimum nominal 5/8 inch APA Span-Rated plywood	No. 8 x 2-1/2 inch bugle head screws spaced 6 inches oc at board edge and 12 inches oc into framing members	Georgia Pacific 1/4 inch minimum DensDeck board or 1/4 inch minimum United States Gypsum Co SECUROCK Glass-Mat Roof Board (Type SGMRX), National Gypsum DEXcell Glass Mat Roof Board or DEXcell FV Glass Mat Roof Board, CertainTeed Gypsum GlasRoc or 1/2 inch minimum UL Certified gypsum board with all joints staggered a min of 6 in. from the plywood joints, or one layer GAF VersaShield Solo Underlayment or Polyglass USA Inc Polystick XFR Underlayment	(2) Minimum 1/4-13 x 1-5/8 inch truss head screws spaced 36 inches oc	<b>-52.5</b>

<sup>1</sup>These assemblies comply with UL790 (ASTM E108) for Class A fire performance at an unlimited slope

<sup>2</sup>All side and butt joints to be sealed with urethane caulk

<sup>3</sup>Structural members spaced maximum 24 inches oc

<sup>4</sup>Any UL Certified Type G1, G2 or G3 base or ply sheet, Type 15 or 30 felt or Prepared Roofing Accessory may be used directly below the metal roof cover

<sup>5</sup>Meets Class 4 Impact Rating

**TABLE 1: WIND UPLIFT ASSEMBLIES<sup>1</sup> (continued)**

System Number	Combustible Deck		Barrier Product	Metal Panel <sup>4</sup> Attachment	Allowable Uplift Pressure UL 580
	Wood Sheathing <sup>2</sup>	Attachment <sup>3</sup>			
<b>Minimum 24 Gauge Steel Premier-Lock 100<sup>5</sup>, Maximum 16 inches wide</b>					<b>Class 90</b>
<b>15</b>	Minimum nominal 5/8 inch APA Span-Rated plywood	No. 8 x 2-1/2 inch bugle head screws or #8d annular ring shank nails spaced 6 inches oc at board edge and 12 inches oc into framing members <sup>5</sup>	Georgia Pacific 1/4 in. min DensDeck board or 1/4 inch minimum United States Gypsum Co SECUROCK Glass-Mat Roof Board (Type SGMRX), National Gypsum DEXcell Glass Mat Roof Board or DEXcell FV Glass Mat Roof Board, CertainTeed Gypsum GlasRoc or 1/2 inch minimum UL Certified gypsum board with all joints staggered a min of 6 in. from the plywood joints, or one layer Versashield® SOLO™ Fire Resistant Slip Sheet	(1) Minimum No. 10-12 x 1 inch pancake head screws spaced 16 inches oc	<b>-52.5</b>
<b>16 oz. Copper MS-150<sup>5</sup>, Maximum 16 inches wide</b>					<b>Class 90</b>
<b>16</b>	Minimum nominal 5/8 inch APA Span-Rated plywood	No. 8 x 2-1/2 inch bugle head screws spaced 6 inches oc at board edge and 12 inches oc into framing members <sup>5</sup>	Georgia Pacific 1/4 inch minimum DensDeck board or 1/4 inch minimum United States Gypsum Co SECUROCK Glass-Mat Roof Board (Type SGMRX), National Gypsum DEXcell Glass Mat Roof Board or DEXcell FV Glass Mat Roof Board, CertainTeed Gypsum GlasRoc or 1/2 inch minimum UL Certified gypsum board with all joints staggered a min of 6 in. from the plywood joints, or one layer GAF VersaShield Solo Underlayment or Polyglass USA Inc Polystick XFR Underlayment	(2) Minimum 1/4-13 x 1-5/8 inch truss head screws spaced 36 inches oc	<b>-52.5</b>

<sup>1</sup>These assemblies comply with UL790 (ASTM E108) for Class A fire performance at an unlimited slope

<sup>2</sup>All side and butt joints to be sealed with urethane caulk

<sup>3</sup>Structural members spaced maximum 24 inches oc

<sup>4</sup>Any UL Certified Type G1, G2 or G3 base or ply sheet, Type 15 or 30 felt or Prepared Roofing Accessory may be used directly below the metal roof cover

<sup>5</sup>Meets Class 4 Impact Rating

**TABLE 1: WIND UPLIFT ASSEMBLIES<sup>1</sup> (continued)**

System Number	Combustible Deck		Barrier Product Configuration	Metal Panel <sup>4</sup> Attachment	Allowable Uplift Pressure UL 580
	Wood Sheathing <sup>2</sup>	Attachment <sup>3</sup>			
<b>Minimum 24 Gauge Steel Premier-Lock 150<sup>5</sup>, Maximum 14-½ inches wide</b>					<b>Class 90</b>
<b>17</b>	Minimum nominal 5/8 inch APA Span-Rated plywood	No. 8 x 2-½ inch bugle head screws or #8d annular ring shank nails spaced 6 inches oc at board edge and 12 inches oc into framing members	Georgia Pacific ¼ inch minimum DensDeck board or ¼ inch minimum United States Gypsum Co SECUROCK Glass-Mat Roof Board (Type SGMRX), National Gypsum DEXcell Glass Mat Roof Board or DEXcell FV Glass Mat Roof Board, CertainTeed Gypsum GlasRoc or ½ inch minimum UL Certified gypsum board with all joints staggered a min of 6 in. from the plywood joints, or one layer GAF VersaShield Underlayment or Polyglass USA Inc Polystick XFR Underlayment	(4) Minimum No. 10-12 x 1 inch pancake head screws spaced 18 inches oc	<b>-52.5</b>
<b>Minimum 22 Gauge Steel Premier-Lock 150<sup>5</sup>, Maximum 16-¼ inches wide</b>					<b>Class 90</b>
<b>18</b>	Minimum nominal 5/8 inch thick APA Span-Rated plywood	No. 8 x 2-½ inch bugle head screws or #8d annular ring shank nails spaced 6 inches oc at board edge and 12 inches oc into framing members	Georgia Pacific ¼ inch minimum DensDeck board or ¼ inch minimum United States Gypsum Co SECUROCK Glass-Mat Roof Board (Type SGMRX), National Gypsum DEXcell Glass Mat Roof Board or DEXcell FV Glass Mat Roof Board, CertainTeed Gypsum GlasRoc or ½ inch minimum UL Certified gypsum board with all joints staggered a min of 6 in. from the plywood joints, or one layer Versashield® SOLO™ Fire Resistant Slip Sheet	(1) Minimum No. 10 x 1 inch pancake head screws spaced 20-¾ inches oc	<b>-52.5</b>

<sup>1</sup>These assemblies comply with UL790 (ASTM E108) for Class A fire performance at an unlimited slope

<sup>2</sup>All side and butt joints to be sealed with urethane caulk

<sup>3</sup>Structural members spaced maximum 24 inches oc

<sup>4</sup>Any UL Certified Type G1, G2 or G3 base or ply sheet, Type 15 or 30 felt or Prepared Roofing Accessory may be used directly below the metal roof cover

<sup>5</sup>Meets Class 4 Impact Rating

**TABLE 1: WIND UPLIFT ASSEMBLIES<sup>1</sup> (continued)**

System Number	Combustible Deck		Barrier Product Configuration <sup>5</sup>	Metal Panel <sup>4</sup> Attachment	Allowable Uplift Pressure UL 580
	Wood Sheathing <sup>2</sup>	Attachment <sup>3</sup>			
<b>Minimum 24 Gauge Steel Clip-Lock 150<sup>5</sup>, Maximum 16 inches wide</b>					<b>Class 90</b>
<b>19</b>	Minimum nominal 5/8 inch thick APA Span-Rated plywood	No. 8 x 2-1/2 inch bugle head screws or #8d annular ring shank nails spaced 6 inches oc at board edge and 12 inches oc into framing members	Georgia Pacific 1/4 inch minimum DensDeck board or 1/4 inch minimum United States Gypsum Co SECUROCK Glass-Mat Roof Board (Type SGMRX), National Gypsum DEXcell Glass Mat Roof Board or DEXcell FV Glass Mat Roof Board, CertainTeed Gypsum GlasRoc or 1/2 inch minimum UL Certified gypsum board with all joints staggered a min of 6 in. from the plywood joints, or one layer Versashield® SOLO™ Fire Resistant Slip Sheet	(2) Minimum No. 10-12 x 1 inch pancake head screws spaced 36 inches oc	<b>-52.5</b>
<b>20</b>	Minimum nominal 1/2 inch thick APA Span-Rated plywood	No. 7-6 coarse thread, No. 1 Phillips drive, bugle-head, coated steel wood screws.	Georgia Pacific 1/4 inch minimum DensDeck board or 1/4 inch minimum United States Gypsum Co SECUROCK Glass-Mat Roof Board (Type SGMRX), National Gypsum DEXcell Glass Mat Roof Board or DEXcell FV Glass Mat Roof Board, CertainTeed Gypsum GlasRoc or 1/2 inch minimum UL Certified gypsum board with all joints staggered a min of 6 in. from the plywood joints, or one layer Versashield® SOLO™ Fire Resistant Slip Sheet	(2) Minimum No. 10-12 x 1 inch pancake head screws spaced 36 inches oc	<b>-52.5</b>

<sup>1</sup>These assemblies comply with UL790 (ASTM E108) for Class A fire performance at an unlimited slope

<sup>2</sup>All side and butt joints to be sealed with urethane caulk

<sup>3</sup>Structural members spaced maximum 24 inches oc

<sup>4</sup>Any UL Certified Type G1, G2 or G3 base or ply sheet, Type 15 or 30 felt or Prepared Roofing Accessory may be used directly below the metal roof cover

<sup>5</sup>Meets Class 4 Impact Rating



**TABLE 1: WIND UPLIFT ASSEMBLIES<sup>1</sup> (continued)**

System Number	Combustible Deck		Barrier Product Configuration	Metal Panel <sup>4</sup> Attachment	Allowable Uplift Pressure UL 580
	Wood Sheathing <sup>2</sup>	Attachment <sup>3</sup>			
<b>Minimum 24 Gauge Steel MS-200<sup>5,6</sup>, Maximum 16 inches wide</b>					<b>Class 90</b>
<b>21</b>	Minimum nominal 5/8 inch thick APA Span-Rated plywood or OSB	No. 8 x 1-7/8 inch bugle head screws or #8d annular ring shank nails spaced 6 inches oc at board edge and 12 inches oc into framing members	Georgia Pacific 1/4 inch minimum DensDeck board or 1/4 inch minimum United States Gypsum Co SECUROCK Glass-Mat Roof Board (Type SGMRX), National Gypsum DEXcell Glass Mat Roof Board or DEXcell FV Glass Mat Roof Board, CertainTeed Gypsum GlasRoc or 1/2 inch minimum UL Certified gypsum board with all joints staggered a min of 6 in. from the plywood joints, or one layer Versashield® SOLO™ Fire Resistant Slip Sheet	(2) Minimum No. 10-12 x 1 inch pancake head screws spaced 60 inches oc	<b>-52.5</b>
<b>Minimum 24 Gauge Steel MS-200<sup>5,6</sup>, Maximum 16 inches wide</b>					<b>Class 90</b>
<b>22</b>	Minimum nominal 5/8 inch thick APA Span-Rated plywood	No. 8 x 1-7/8 inch bugle head screws or #8d annular ring shank nails spaced 6 inches oc at board edge and 12 inches oc into framing members	Georgia Pacific 1/4 inch minimum DensDeck board or 1/4 inch minimum United States Gypsum Co SECUROCK Glass-Mat Roof Board (Type SGMRX), National Gypsum DEXcell Glass Mat Roof Board or DEXcell FV Glass Mat Roof Board, CertainTeed Gypsum GlasRoc or 1/2 inch minimum UL Certified gypsum board with all joints staggered a min of 6 in. from the plywood joints, or one layer Versashield® SOLO™ Fire Resistant Slip Sheet	(2) Minimum No. 12-8 flat head screws spaced 30 inches oc	<b>-52.5</b>

<sup>1</sup>These assemblies comply with UL790 (ASTM E108) for Class A fire performance at an unlimited slope

<sup>2</sup>All side and butt joints to be sealed with urethane caulk

<sup>3</sup>Structural members spaced maximum 24 inches oc

<sup>4</sup>Any UL Certified Type G1, G2 or G3 base or ply sheet, Type 15 or 30 felt or Prepared Roofing Accessory may be used directly below the metal roof cover

<sup>5</sup>Meets Class 4 Impact Rating

<sup>6</sup>Panel side laps may be rolled to 90° or 180°

**TABLE 1: WIND UPLIFT ASSEMBLIES<sup>1</sup> (continued)**

System Number	Combustible Deck		Barrier Product Configuration	Metal Panel <sup>4</sup> Attachment	Allowable Uplift Pressure UL 580
	Wood Sheathing <sup>2</sup>	Attachment <sup>3</sup>			
<b>Minimum 24 Gauge Steel MS-200<sup>5,6</sup>, Maximum 16 inches wide</b>					<b>Class 90</b>
<b>23</b>	Minimum nominal 2 inch thick dimensional lumber planks	No. 8 x 1-7/8 inch bugle head screws or #8d annular ring shank nails	Georgia Pacific 1/4 inch minimum DensDeck board or 1/4 inch minimum United States Gypsum Co SECUROCK Glass-Mat Roof Board (Type SGMRX), National Gypsum DEXcell Glass Mat Roof Board or DEXcell FV Glass Mat Roof Board, CertainTeed Gypsum GlasRoc or 1/2 inch minimum UL Certified gypsum board with all joints staggered a min of 6 in. from the plywood joints, or one layer Versashield® SOLO™ Fire Resistant Slip Sheet	(2) No. 14 pancake head screws spaced 24 inches oc	<b>-52.5</b>
<b>Minimum 24 Gauge Steel MS-200<sup>5,6</sup>, Maximum 16 inches wide</b>					<b>Class 90</b>
<b>24</b>	Minimum nominal 5/8 inch thick APA Span-Rated plywood or minimum nominal 2 inch thick dimensional lumber planks	No. 8 x 1-7/8 inch bugle head screws or #8d annular ring shank nails spaced 6 inches oc at board edge and 12 inches oc into framing members	Georgia Pacific 1/4 inch minimum DensDeck board or 1/4 inch minimum United States Gypsum Co SECUROCK Glass-Mat Roof Board (Type SGMRX), National Gypsum DEXcell Glass Mat Roof Board or DEXcell FV Glass Mat Roof Board, CertainTeed Gypsum GlasRoc or 1/2 inch minimum UL Certified gypsum board with all joints staggered a min of 6 in. from the plywood joints, or one layer Versashield® SOLO™ Fire Resistant Slip Sheet	(2) Minimum No. 10-12 x 1 inch pancake head screws spaced 36 inches oc	<b>-52.5</b>

<sup>1</sup>These assemblies comply with UL790 (ASTM E108) for Class A fire performance at an unlimited slope

<sup>2</sup>All side and butt joints to be sealed with urethane caulk

<sup>3</sup>Structural members spaced maximum 24 inches oc

<sup>4</sup>Any UL Certified Type G1, G2 or G3 base or ply sheet, Type 15 or 30 felt or Prepared Roofing Accessory may be used directly below the metal roof cover

<sup>5</sup>Meets Class 4 Impact Rating

<sup>6</sup>Panel side laps may be rolled to 90° or 180°

**TABLE 1: WIND UPLIFT ASSEMBLIES<sup>1</sup> (continued)**

System Number	Combustible Deck		Barrier Product Configuration	Metal Panel <sup>4</sup> Attachment	Allowable Uplift Pressure UL 580
	Wood Sheathing <sup>2</sup>	Attachment <sup>3</sup>			
<b>Minimum 24 Gauge Steel BR-36<sup>5,6</sup>, Maximum 36 inches wide</b>					<b>Class 90</b>
<b>25</b>	Minimum nominal 5/8 inch thick APA Span-Rated plywood	No. 8 x 1-7/8 inch bugle head screws spaced 12 inches oc into framing members	Georgia Pacific 1/4 inch minimum DensDeck board or 1/4 inch minimum United States Gypsum Co SECUROCK Glass-Mat Roof Board (Type SGMRX), National Gypsum DEXcell Glass Mat Roof Board or DEXcell FV Glass Mat Roof Board, CertainTeed Gypsum GlasRoc or 1/2 inch minimum UL Certified gypsum board with all joints staggered a min of 6 in. from the plywood joints, or one layer Versashield® SOLO™ Fire Resistant Slip Sheet	No. 14 by 1-1/2 inch long Type A 5/16 inch hex head steel screw with 9/16 diameter metal washer and bonded neoprene rubber seal spaced 30 inches oc in the bottom flute of the roof panel.	<b>-52.5</b>
<b>Minimum 24 Gauge Steel BR-36<sup>5,6</sup>, Maximum 36 inches wide</b>					<b>Class 30</b>
<b>26</b>	Minimum nominal 5/8 inch thick APA Span-Rated plywood	No. 8 x 1-7/8 inch bugle head screws spaced 12 inches oc into framing members	Georgia Pacific 1/4 inch minimum DensDeck board or 1/4 inch minimum United States Gypsum Co SECUROCK Glass-Mat Roof Board (Type SGMRX), National Gypsum DEXcell Glass Mat Roof Board or DEXcell FV Glass Mat Roof Board, CertainTeed Gypsum GlasRoc or 1/2 inch minimum UL Certified gypsum board with all joints staggered a min of 6 in. from the plywood joints, or one layer Versashield® SOLO™ Fire Resistant Slip Sheet	No. 14 by 1-1/2 inch long Type A 5/16 inch hex head steel screw with 9/16 diameter metal washer and bonded neoprene rubber seal spaced 60 inches oc in the bottom flute of the roof panel.	<b>-15</b>

<sup>1</sup>These assemblies comply with UL790 (ASTM E108) for Class A fire performance at an unlimited slope

<sup>2</sup>All side and butt joints to be sealed with urethane caulk

<sup>3</sup>Structural members spaced maximum 24 inches oc

<sup>4</sup>Any UL Certified Type G1, G2 or G3 base or ply sheet, Type 15 or 30 felt or Prepared Roofing Accessory may be used directly below the metal roof cover

<sup>5</sup>Meets Class 4 Impact Rating

<sup>6</sup>Panel side laps fastened with No. 14 by 7/8 inch long hex head steel screws spaced 12 inches oc

**TABLE 1: WIND UPLIFT ASSEMBLIES<sup>1</sup> (continued)**

System Number	Combustible Deck		Barrier Product Configuration	Metal Panel <sup>4</sup> Attachment	Allowable Uplift Pressure UL 580
	Wood Sheathing <sup>2</sup>	Attachment <sup>3</sup>			
<b>Minimum 26 Gauge Steel Classic 7/8" Corrugated<sup>5,6</sup>, Maximum 36 inches wide</b>					<b>Class 90</b>
<b>27</b>	Minimum nominal 19/32 inch thick Type B-C rated plywood, all butt joints to occur over supports	No. 8 x 1-7/8 inch bugle head screws or #8d annular ring shank nails spaced 6 inches oc at board edge and 6 inches oc into framing members	Georgia Pacific 1/4 inch minimum DensDeck board or 1/4 inch minimum United States Gypsum Co SECUROCK Glass-Mat Roof Board (Type SGMRX), National Gypsum DEXcell Glass Mat Roof Board or DEXcell FV Glass Mat Roof Board, CertainTeed Gypsum GlasRoc or 1/2 inch minimum UL Certified gypsum board with all joints staggered a min of 6 in. from the plywood joints, or one layer Versashield® SOLO™ Fire Resistant Slip Sheet	No. 10-14 x 1 1/2 inch hex-washer head wood screws with bonded neoprene washer spaced 8 inches O.C. across the width and 24 inches O.C. along the length.	<b>-52.5</b>

<sup>1</sup>These assemblies comply with UL790 (ASTM E108) for Class A fire performance at an unlimited slope

<sup>2</sup>All side and butt joints to be sealed with urethane caulk

<sup>3</sup>Structural members spaced maximum 24 inches oc

<sup>4</sup>Any UL Certified Type G1, G2 or G3 base or ply sheet, Type 15 or 30 felt or Prepared Roofing Accessory may be used directly below the metal roof cover

<sup>5</sup>Meets Class 4 Impact Rating

<sup>6</sup>Panel side laps fastened with No. 14 by 7/8 inch long hex head steel screws spaced 12 inches oc

**TABLE 2: WIND UPLIFT ASSEMBLIES<sup>1</sup>**

System Number	Noncombustible Deck	Insulation <sup>2</sup>	Coverboard or Barrier Product	Ply Sheet	Metal Panel Attachment	Allowable Uplift Pressure UL 580
	Steel Decking					
<b>Minimum 24 Gauge Steel BR-36<sup>3</sup>, Maximum 36 inches wide</b>						<b>Class 90</b>
<b>28</b>	Minimum 22 MSG, 50 ksi steel <sup>4</sup>	Any UL Listed Polyisocyanurate glass fiber, perlite or wood fiber, maximum 10-inches thick <sup>5</sup>	Minimum ½ inch thick tongue and groove UL Certified gypsum board, butt end joints staggered over top flutes of steel deck.	Any UL Certified Type G1, G2 or G3 base or ply sheet, Type 15 or 30 felt or UL Certified Prepared Roofing Accessory	No. 12-14 T3 flanged hex head steel screws with neoprene rubber seal installed 24 inches oc	<b>-52.5</b>
<b>Minimum 24 Gauge Steel BR-36<sup>3,6</sup>, Maximum 36 inches wide</b>						<b>Class 60</b>
<b>29</b>	Minimum 22 MSG, 50 ksi steel <sup>4</sup>	Any UL Listed Polyisocyanurate glass fiber, perlite or wood fiber, maximum 10-inches thick <sup>5</sup>	Minimum ½ inch thick tongue and groove UL Certified gypsum board, butt end joints staggered over top flutes of steel deck.	Any UL Certified Type G1, G2 or G3 base or ply sheet, Type 15 or 30 felt or UL Certified Prepared Roofing Accessory	No. 12-14 T3 flanged hex head steel screws with neoprene rubber seal installed 60 inches oc	<b>-30</b>

<sup>1</sup>These assemblies comply with UL790 (ASTM E108) for Class A fire performance at an unlimited slope

<sup>2</sup>6 mil vapor barrier may be used between steel deck and foam plastic insulation

<sup>3</sup>Meets Class 4 Impact Rating

<sup>4</sup>Structural supports to be minimum 16 GA spaced maximum 60 inches oc

<sup>5</sup>Fasteners used to attach insulation layer to steel deck to be minimum No. 11-13 truss head screws and penetrate steel deck by minimum ½ inch

<sup>6</sup>Panel side laps fastened with No. 14 by ⅞ inch long hex head steel screws spaced 12 inches oc

**TABLE 2: WIND UPLIFT ASSEMBLIES<sup>1</sup>**

System Number	Noncombustible Deck	Insulation <sup>2</sup>	Coverboard or Barrier Product	Ply Sheet	Metal Panel Attachment	Allowable Uplift Pressure UL 580
	Steel Decking					
<b>Minimum 24 Gauge Steel MS-200<sup>3</sup>, Maximum 16 inches wide</b>						<b>Class 90</b>
<b>30</b>	Minimum 22 ksi MSG, 33 ksi steel <sup>4</sup>	Any UL Listed Polyisocyanurate glass fiber, perlite or wood fiber, any thickness <sup>5</sup>	Minimum ½ inch thick tongue and groove UL Certified gypsum board, butt end joints staggered over top flutes of steel deck.	Any UL Certified Type G1, G2 or G3 base or ply sheet, Type 15 or 30 felt or UL Certified Prepared Roofing Accessory	(1) No. 18 hex washer head screws spaced 48 inches oc or (2) No. 14 truss head screws spaced 20 inches oc <sup>6</sup>	<b>-52.5</b>
<b>Minimum 24 Gauge Steel MS-200<sup>3,7</sup>, Maximum 16 inches wide</b>						<b>Class 90</b>
<b>31</b>	Minimum 22 ksi MSG, 33 ksi steel <sup>4</sup>	Any UL Listed Polyisocyanurate glass fiber, perlite or wood fiber, any thickness <sup>5</sup>	See TGIK Listing for optional components.	Any UL Certified Type G1, G2 or G3 base or ply sheet, Type 15 or 30 felt or UL Certified Prepared Roofing Accessory	(1) No. 11 hex washer head screws spaced 30 inches oc	<b>-52.5</b>
<b>Minimum 24 Gauge Steel MS-200<sup>3</sup>, Maximum 16 inches wide</b>						<b>Class 90</b>
<b>32</b>	Minimum 22 ksi MSG, 33 ksi steel <sup>8</sup>	Any UL Listed Polyisocyanurate glass fiber, perlite or wood fiber, any thickness <sup>5</sup>	See TGIK Listing for optional components.	Any UL Certified Type G1, G2 or G3 base or ply sheet, Type 15 or 30 felt or UL Certified Prepared Roofing Accessory	(2) No. 14 truss head screws spaced 48 inches oc	<b>-52.5</b>

<sup>1</sup>These assemblies comply with UL790 (ASTM E108) for Class A fire performance at an unlimited slope

<sup>2</sup>6 mil vapor barrier may be used between steel deck and foam plastic insulation

<sup>3</sup>Meets Class 4 Impact Rating

<sup>4</sup>Structural supports spaced maximum 60 inches oc

<sup>5</sup>Fasteners used to attach insulation layer to steel deck to be minimum No. 11-13 truss head screws and penetrate steel deck by minimum ½ inch

<sup>6</sup>Insulation bearing plate not required if coverboard is used

<sup>7</sup>Panel side laps may be rolled to 90° or 180°

<sup>8</sup>Structural supports spaced maximum 72 inches oc

**TABLE 2: WIND UPLIFT ASSEMBLIES<sup>1</sup> (continued)**

System Number	Noncombustible Deck	Insulation <sup>2</sup>	Coverboard or Barrier Product	Ply Sheet	Metal Panel Attachment	Allowable Uplift Pressure UL 580
	Steel Decking					
<b>Minimum 24 Gauge Steel MS-200<sup>3</sup>, Maximum 16 inches wide</b>						<b>Class 90</b>
<b>33</b>	Minimum 22 MSG, 33 ksi steel <sup>4</sup>	Any UL Listed Polyisocyanurate glass fiber, perlite or wood fiber, any thickness <sup>5</sup>	See TGIK Listing for components.	Any UL Certified Type G1, G2 or G3 base or ply sheet, Type 15 or 30 felt or UL Certified Prepared Roofing Accessory	(2) No. 14 truss head screws spaced 20 inches oc, or (1) with continuous clip fastened 8 inches oc	<b>-52.5</b>
<b>Minimum 24 Gauge Steel T-Panel Narrow Batten<sup>5</sup>, Maximum 21-1/4 inches wide</b>						<b>Class 90</b>
<b>34</b>	Minimum 22 MSG, 33 ksi steel	Any UL Listed Polyisocyanurate glass fiber, perlite or wood fiber, any thickness <sup>5</sup>	Minimum 2.00 pcf extruded polystyrene foamed plastic insulation boards, maximum 4 inches thick.	Any UL Certified Type G1, G2 or G3 base or ply sheet, Type 15 or 30 felt or UL Certified Prepared Roofing Accessory	(1) Minimum No. 14 truss head screws spaced 20 inches oc spaced 24 inches oc	<b>-52.5</b>

<sup>1</sup>These assemblies comply with UL790 (ASTM E108) for Class A fire performance at an unlimited slope

<sup>2</sup>6 mil vapor barrier may be used between steel deck and foam plastic insulation

<sup>3</sup>Meets Class 4 Impact Rating

<sup>4</sup>Structural supports spaced maximum 60 inches oc

<sup>5</sup>Fasteners used to attach insulation layer to steel deck to be minimum No. 11-13 truss head screws and penetrate steel deck by minimum 1/2 inch

<sup>6</sup>Insulation bearing plate not required if coverboard is used

**TABLE 2: WIND UPLIFT ASSEMBLIES<sup>1</sup> (continued)**

System Number	Noncombustible Deck	Insulation <sup>3</sup>	Coverboard or Barrier Product	Ply Sheet	Metal Panel Attachment	Allowable Uplift Pressure UL 580
	Steel Decking <sup>2</sup>					
<b>Minimum 24 Gauge Steel MS-200<sup>4,8</sup>, Maximum 16 inches wide</b>						<b>Class 90</b>
<b>35</b>	Minimum 22 MSG steel <sup>5</sup>	Maximum 4 inch thick, any UL Listed rigid foam insulation, minimum 2.25 pcf density	Optional-Min <sup>15</sup> / <sub>32</sub> inch plywood, or min <sup>7</sup> / <sub>16</sub> inch thick OSB, ½ inch thick gypsum board, ½ inch wood fiberboard, ¼ inch min. thickness G-P Gypsum DensDeck, ¼ inch min thick USG SECUROCK Glass Mat Board or SECUROCK Roof Board applied over steel deck in lieu of Foamed Plastic or over Foamed Plastic <sup>6</sup>	Any UL Certified Type G1, G2 or G3 base or ply sheet, Type 15 or 30 felt or UL Certified prepared	(1) No. 12 washered hex-head self-drilling steel screw maximum 24 inches oc <sup>7</sup> with continuous clip	<b>-52.5</b>
<b>Minimum 24 Gauge Steel MS-200<sup>4,8</sup>, Maximum 18 inches wide</b>						<b>Class 90</b>
<b>36</b>	Minimum 22 MSG steel <sup>9</sup>	Any UL Listed Polyisocyanurate glass fiber, perlite or wood fiber, any thickness	Optional-Min <sup>15</sup> / <sub>32</sub> inch plywood, or min <sup>7</sup> / <sub>16</sub> inch thick OSB, ½ inch thick gypsum board, ½ inch wood fiberboard, ¼ inch min. thickness G-P Gypsum DensDeck, ¼ inch min thick USG SECUROCK Glass Mat Board or SECUROCK Roof Board applied over steel deck in lieu of Foamed Plastic or over Foamed Plastic <sup>6</sup>	Any UL Certified Type G1, G2 or G3 base or ply sheet, Type 15 or 30 felt or UL Certified Prepared Roofing Accessory	(2) No. 12 washered hex-head self-drilling steel screw maximum 48 inches oc <sup>7</sup>	<b>-52.5</b>

<sup>1</sup>These assemblies comply with UL790 (ASTM E108) for Class A fire performance at an unlimited slope

<sup>2</sup>Minimum 33 ksi

<sup>3</sup>6 mil vapor barrier may be used between steel deck and foam plastic insulation

<sup>4</sup>Meets Class 4 Impact Rating

<sup>5</sup>Structural supports spaced maximum 48 inches oc

<sup>6</sup>Fasteners used to attach insulation layer to steel deck to be minimum No. 11-13 truss head screws and penetrate steel deck by minimum ½ inch

<sup>7</sup>Insulation bearing plate not required if coverboard is used

<sup>8</sup>Panel side laps may be rolled to 90° or 180°

<sup>9</sup>Structural supports spaced maximum 60 inches oc



**TABLE 2: WIND UPLIFT ASSEMBLIES<sup>1</sup> (continued)**

System Number	Noncombustible Deck	Insulation <sup>3</sup>	Coverboard or Barrier Product	Ply Sheet	Metal Panel Attachment	Allowable Uplift Pressure UL 580
	Steel Decking <sup>2</sup>					
<b>Minimum 24 Gauge Steel MS-200<sup>4, 5</sup>, Maximum 18 inches wide</b>						<b>Class 90</b>
<b>37</b>	Minimum 22 MSG steel <sup>6</sup>	Any UL Listed Polyisocyanurate glass fiber, perlite or wood fiber, any thickness	Optional-Min <sup>15</sup> / <sub>32</sub> inch plywood, or min <sup>7</sup> / <sub>16</sub> inch thick OSB, 1/2 inch thick gypsum board, 1/2 inch wood fiberboard, 1/4 inch min. thickness G-P Gypsum DensDeck, 1/4 inch min thick USG SECUROCK Glass Mat Board or SECUROCK Roof Board applied over steel deck in lieu of Foamed Plastic or over Foamed Plastic <sup>7</sup>	Any UL Certified Type G1, G2 or G3 base or ply sheet, Type 15 or 30 felt or UL Certified Prepared Roofing Accessory	(2) No. 14 truss head screws spaced 48 inches oc through NC3300, NCF-3300, NCF-3300-SS Series Clip with bearing plate <sup>8</sup>	<b>-52.5</b>
<b>Minimum 24 Gauge Steel Versa Span<sup>4</sup>, Maximum 18 inches wide</b>						<b>Class 90</b>
<b>38</b>	Minimum 22 MSG steel <sup>6</sup>	Any UL Listed Polyisocyanurate glass fiber, perlite or wood fiber, any thickness, or 5 inch composite structural fiber cement with foam plastic core	Optional-Min <sup>15</sup> / <sub>32</sub> inch plywood, or min <sup>7</sup> / <sub>16</sub> inch thick OSB, 1/2 inch thick gypsum board, 1/2 inch wood fiberboard, 1/4 inch min. thickness G-P Gypsum DensDeck, 1/4 inch min thick USG SECUROCK Glass Mat Board or SECUROCK Roof Board applied over steel deck in lieu of Foamed Plastic or over Foamed Plastic <sup>7</sup>	Any UL Certified Type G1, G2 or G3 base or ply sheet, Type 15 or 30 felt or UL Certified Prepared Roofing Accessory	(2) Minimum No. 10-16 x 1 inch pancake head screws or (2) No. 14 truss head screws spaced 48 inches oc Clip with bearing plate <sup>8</sup>	<b>-52.5</b>

<sup>1</sup>These assemblies comply with UL790 (ASTM E108) for Class A fire performance at an unlimited slope

<sup>2</sup>Minimum 33 ksi

<sup>3</sup>6 mil vapor barrier may be used between steel deck and foam plastic insulation

<sup>4</sup>Meets Class 4 Impact Rating

<sup>5</sup>Structural supports spaced maximum 48 inches oc

<sup>6</sup>Structural supports spaced maximum 60 inches oc

<sup>7</sup>Fasteners used to attach insulation layer to steel deck to be minimum No. 11-13 truss head screws and penetrate steel deck minimum 1/2 inch

<sup>8</sup>Insulation bearing plate not required if coverboard is used

**TABLE 2: WIND UPLIFT ASSEMBLIES<sup>1</sup> (continued)**

System Number	Noncombustible Deck	Insulation	Coverboard or Barrier Product	Ply Sheet	Metal Panel Attachment	Allowable Uplift Pressure UL 580
	Steel Decking <sup>2</sup>					
<b>24 Gauge Steel Versa Span<sup>3</sup>, Maximum 18 inches wide</b>						<b>Class 90</b>
<b>39</b>	Minimum 22 MSG steel <sup>4</sup>	Any UL Listed Polyisocyanurate glass fiber, perlite or wood fiber, any thickness, or 5 inch composite structural fiber cement with foam plastic core	Minimum 7/16 inch thick APA rated OSB <sup>5</sup>	Any UL Certified Type G1, G2 or G3 base or ply sheet, Type 15 or 30 felt or UL Certified Prepared Roofing Accessory	(2) No. 10-12 hex washer head screws spaced 36 inches oc in NC3300, NCF-3300, NCF-3300-SS Series Clip <sup>6</sup>	<b>-52.5</b>
<b>Minimum .032 Aluminum Versa Span<sup>4</sup>, Maximum 16 inches wide</b>						<b>Class 90</b>
<b>40</b>	Minimum 22 MSG steel <sup>4</sup>	Optional-Any UL Listed Polyisocyanurate glass fiber, perlite or wood fiber, any thickness, or 5 inch composite structural fiber cement with foam plastic core	Optional-Min 15/32 inch plywood, or min 7/16 inch thick OSB, 1/2 inch thick gypsum board, 1/2 inch wood fiberboard, 1/4 inch min. thickness G-P Gypsum DensDeck, 1/4 inch min thick USG SECUROCK Glass Mat Board or SECUROCK Roof Board applied over steel deck in lieu of Foamed Plastic or over Foamed Plastic <sup>5</sup>	Any UL Certified Type G1, G2 or G3 base or ply sheet, Type 15 or 30 felt or UL Certified Prepared Roofing Accessory	(2) No. 14 truss head screws spaced 18 inches oc through NC3300, NCF-3300, NCF-3300-SS Series Clip with bearing plate <sup>6</sup>	<b>-52.5</b>

<sup>1</sup>These assemblies comply with UL790 (ASTM E108) for Class A fire performance at an unlimited slope

<sup>2</sup>Minimum 33 ksi

<sup>3</sup>Meets Class 4 Impact Rating

<sup>4</sup>6 mil vapor barrier may be used between steel deck and foam plastic insulation

<sup>5</sup>Fasteners used to attach insulation layer to steel deck to be minimum No. 11-13 truss head screws and penetrate steel deck minimum 1/2-inch

<sup>6</sup>Insulation bearing plate not required if coverboard is used

**TABLE 3: WIND UPLIFT ASSEMBLIES<sup>1</sup> (continued)**

System Number	Insulation	Metal Panel Attachment	Allowable Uplift Pressure UL 580
<b>Minimum 24 Gauge Steel MS-200<sup>2</sup>, Maximum 18 inches wide</b>			<b>Class 90</b>
<b>41</b>	Optional- Any compressible blanket insulation 8 in. max thick before compression, or 6 in. max thick when located between supports <sup>3</sup>	(2) Minimum ¼-14 x 1 inch truss head screws	<b>-52.5</b>
<b>Minimum 24 Gauge Steel MS-200<sup>2</sup>, Maximum 16 inches wide</b>			<b>Class 90</b>
<b>42</b>	Optional- Any compressible blanket insulation 8 in. max thick before compression, or 6 in. max thick when located between supports <sup>3</sup>	(2) Minimum ¼-14 x 1 inch truss head screws	<b>-52.5</b>
<b>43</b>	Optional- Any compressible blanket insulation 8 in. max thick before compression, or 6 in. max thick when located between supports <sup>4</sup>	(2) No. 12 x 1 hex washer head screw when continuous or non-continuous clip is used	<b>-52.5</b>
<b>Minimum 24 Gauge Steel Versa Span<sup>2</sup>, Maximum 12 inches wide</b>			<b>Class 90</b>
<b>44</b>	Optional- Any UL Listed rigid roofing insulation board; Any compressible blanket insulation 8 in. max thick before compression, or 6 in. max thick when located between supports <sup>3</sup>	(2) Minimum No. 10-16 x 1 inch pancake head screws or No. 14-13 DPI carbon, pancake head screw when rigid insulation is used.	<b>-52.5</b>
<b>Minimum 24 Gauge Steel Versa Span<sup>2</sup>, Maximum 18 inches wide</b>			<b>Class 60</b>
<b>45</b>	Optional-Any UL Listed rigid roofing insulation board; Any compressible blanket insulation 8 in. max thick before compression, or 6 in. max thick when located between supports <sup>4</sup>	(2) Minimum No. 10-16 x 1 inch pancake head screws or No. 14-13 DPI carbon, pancake head screw when rigid insulation is used.	<b>-30</b>
<b>Minimum 24 Gauge Steel Versa Span<sup>2</sup>, Maximum 18 inches wide</b>			<b>Class 90</b>
<b>46</b>	Optional-Any compressible blanket insulation 8 in. max thick before compression, or 6 in. max thick when located between supports <sup>3</sup>	(2) Minimum No. 10-16 x 1 inch pancake head or ¼-14 x 1 inch truss head screws.	<b>-52.5</b>

<sup>1</sup>Non-decked, open framing construction

<sup>2</sup>Meets Class 4 Impact Rating

<sup>3</sup>Structural supports spaced maximum 48 inches oc

<sup>4</sup>Structural supports spaced maximum 60 inches oc

**TABLE 3: WIND UPLIFT ASSEMBLIES<sup>1</sup> (continued)**

<b>System Number</b>	<b>Insulation</b>	<b>Metal Panel Attachment</b>	<b>Allowable Uplift Pressure UL 580</b>
<b>Minimum 24 Gauge Steel Versa Span<sup>2</sup>, Maximum 10-½ inches wide</b>			<b>Class 90</b>
<b>47</b>	Optional- Any UL Listed rigid roofing insulation board; Any compressible blanket insulation 8 in. max thick before compression, or 6 in. max thick when located between supports <sup>3</sup>	(2) Minimum No. 10-16 x 1 inch pancake head screws or No. 14-13 DPI carbon, pancake head screw when rigid insulation is used.	<b>-52.5</b>
<b>48</b>	Optional-Any compressible blanket insulation 8 in. max thick before compression, or 6 in. max thick when located between supports <sup>4</sup>	¼-14 x 1-¼ inch hex head screws.	<b>-52.5</b>
<b>Minimum 22 Gauge Steel Versa Span<sup>2</sup>, Maximum 10-½ inches wide</b>			<b>Class 90</b>
<b>49</b>	Optional-Any UL Listed rigid roofing insulation board; Any compressible blanket insulation 8 in. max thick before compression, or 6 in. max thick when located between supports <sup>4</sup>	(2) Minimum No. 10-16 x 1 inch pancake head screws or No. 14-13 DPI carbon, pancake head screw when rigid insulation is used.	<b>-52.5</b>
<b>Minimum 22 Gauge Steel Versa Span<sup>2</sup>, Maximum 12 inches wide</b>			<b>Class 90</b>
<b>50</b>	Any compressible blanket insulation 8 in. max thick before compression, or 6 in. max thick when located between supports <sup>4</sup>	(2) Minimum No. 10-16 x 1 inch pancake head or ¼-14 x 1 inch truss head screws.	<b>-52.5</b>
<b>Minimum .032 Aluminum Versa Span<sup>2</sup>, Maximum 10-½ inches wide</b>			<b>Class 60</b>
<b>51</b>	Optional- Any UL Listed rigid roofing insulation board; Any compressible blanket insulation 8 in. max thick before compression, or 6 in. max thick when located between supports <sup>3</sup>	(2) Minimum No. 10-16 x 1 inch pancake head screws or No. 14-13 DPI carbon, pancake head screw when rigid insulation is used.	<b>-30</b>

<sup>1</sup>Non-decked, open framing construction

<sup>2</sup>Meets Class 4 Impact Rating

<sup>3</sup>Structural supports spaced maximum 48 inches oc

<sup>4</sup>Structural supports spaced maximum 60 inches oc

**TABLE 3: WIND UPLIFT ASSEMBLIES<sup>1</sup> (continued)**

<b>System Number</b>	<b>Insulation</b>	<b>Metal Panel Attachment</b>	<b>Allowable Uplift Pressure UL 580</b>
<b>Minimum .032 Aluminum Versa Span<sup>2</sup>, Maximum 10-½ inches wide</b>			<b>Class 90</b>
<b>52</b>	Optional- Any UL Listed rigid roofing insulation board; Any compressible blanket insulation 8 in. max thick before compression, or 6 in. max thick when located between supports <sup>4</sup>	(2) Minimum No. 10-16 x 1 inch pancake head screws or No. 14-13 DPI carbon, pancake head screw when rigid insulation is used.	<b>-52.5</b>
<b>Minimum 24 Gauge Steel Versa Span<sup>2</sup>, Maximum 10 inches wide</b>			<b>Class 90</b>
<b>53</b>	Optional-Any compressible blanket insulation 8 in. max thick before compression, or 6 in. max thick when located between supports <sup>3</sup>	(2) Minimum No. 10-16 x 1 inch pancake head screws.	<b>-52.5</b>
<b>Minimum 22 Gauge Steel Versa Span<sup>2</sup>, Maximum 10 inches wide</b>			<b>Class 90</b>
<b>54</b>	Optional-Any compressible blanket insulation 8 in. max thick before compression, or 6 in. max thick when located between supports <sup>5</sup>	(2) Minimum No. 10-16 x 1 inch pancake head screws.	<b>-52.5</b>
<b>Minimum 22 Gauge Steel Versa Span<sup>2</sup>, Maximum 21-¼ inches wide</b>			<b>Class 60</b>
<b>55</b>	Optional-Any compressible blanket insulation 8 in. max thick before compression, or 6 in. max thick when located between supports <sup>5</sup>	(2) Minimum No. 10-16 x 1 inch pancake head or ¼-14 x 1 inch truss head screws.	<b>-30</b>
<b>Minimum .032 Aluminum Versa Span<sup>2</sup>, Maximum 10 inches wide</b>			<b>Class 90</b>
<b>56</b>	Optional-Any compressible blanket insulation 8 in. max thick before compression, or 6 in. max thick when located between supports <sup>4</sup>	(2) Minimum No. 10-16 x 1 inch pancake head screws.	<b>-52.5</b>

<sup>1</sup>Non-decked, open framing construction

<sup>2</sup>Meets Class 4 Impact Rating

<sup>3</sup>Structural supports spaced maximum 48 inches oc

<sup>4</sup>Structural supports spaced maximum 36 inches oc

<sup>5</sup>Structural supports spaced maximum 60 inches oc

**TABLE 3: WIND UPLIFT ASSEMBLIES<sup>1</sup> (continued)**

<b>System Number</b>	<b>Insulation</b>	<b>Fasteners</b>	<b>Metal Panel Attachment</b>	<b>Allowable Uplift Pressure UL 580</b>
<b>Minimum 26 Gauge Steel PBR<sup>2</sup>, Maximum 36 inches wide</b>				<b>Class 90<sup>4</sup></b>
<b>57</b>	Optional- Any compressible blanket insulation, maximum 4 inches thick before compression.	No. 14 self-tapping, hex-head, plated steel or stainless steel screws with a separate 5/8 inch O.D. steel or aluminum washer and a separate neoprene sealing washer	4-8-4-8 inch pattern 2 inches from the center line each side of each major rib and at end laps into minimum 14 MSG gauge steel purlins. <sup>3</sup> Side lap fasteners maximum 20 inches O.C.	<b>-52.5</b>
<b>Minimum 26 Gauge Steel PBR<sup>2</sup>, Maximum 36 inches wide</b>				<b>Class 30<sup>6</sup></b>
<b>58</b>	Optional- Any compressible blanket insulation, maximum 4 inches thick before compression.	No. 14 self-tapping, hex-head, plated steel or stainless steel screws with a separate 5/8 inch O.D. steel or aluminum washer and a separate neoprene sealing washer	12 inches O.C. 2 inches from the center line of each major rib and at end laps into minimum 16 MSG gauge steel purlins. <sup>5</sup> Side lap fasteners maximum 20 inches O.C.	<b>-15.0</b>
<b>Minimum 26 Gauge Steel PBR<sup>2</sup>, Maximum 36 inches wide</b>				<b>Class 90<sup>3, 7</sup></b>
<b>59</b>	Optional- Any compressible blanket insulation, maximum 4 inches thick before compression.	No. 12-14 self-tapping, hex-head, plated steel screws with a separate 1/2 inch OD formed steel washer and a separate neoprene sealing washer. Length to be 1 inch for maximum 3 inch thick insulation and 1 1/4 inches for insulation greater than 3 inches.	6 inches OC located 3 inches from center line on both sides of each major rib and at end laps and 18 inches OC at side laps.	<b>-52.5</b>

<sup>1</sup>Non-decked, open framing construction

<sup>2</sup>Meets Class 4 Impact Rating

<sup>3</sup>Structural supports spaced maximum 60 3/16 inches oc

<sup>5</sup>Structural supports spaced maximum 63 1/4 inches oc

<sup>4</sup>Structural supports minimum 14 MSG 50 ksi steel

<sup>6</sup>Structural supports minimum 16 MSG 50 ksi steel

<sup>7</sup>Structural supports minimum 13 MSG 55 ksi steel

**TABLE 3: WIND UPLIFT ASSEMBLIES<sup>1</sup> (continued)**

<b>System Number</b>	<b>Insulation</b>	<b>Fasteners</b>	<b>Metal Panel Attachment</b>	<b>Allowable Uplift Pressure UL 580</b>
<b>Minimum 26 Gauge Steel PBR<sup>2</sup>, Maximum 36 inches wide</b>				<b>Class 60<sup>3,4</sup></b>
<b>60</b>	Optional- Any compressible blanket insulation, maximum 4 inches thick before compression.	No. 12-14 self-tapping, hex-head, plated steel screws with a separate ½ inch OD formed steel washer and a separate neoprene sealing washer. Length to be 1 inch for maximum 3 inch thick insulation and 1¼ inches for insulation greater than 3 inches.	12 inches OC beginning 2½ inches from the center line on one side of each major rib; 6 inches OC beginning 3 inches from center line on both sides of each major rib at end laps and 18 inches OC at side laps.	<b>-30.0</b>
<b>Minimum 26 Gauge Steel PBR<sup>2</sup>, Maximum 36 inches wide</b>				<b>Class 90<sup>5,6</sup></b>
<b>61</b>	Optional- Any compressible blanket insulation, maximum 4 inches thick before compression.	No. 12-14 self-tapping, hex-head, plated steel screws with a separate ½ inch OD formed steel washer and a separate neoprene sealing washer. Length to be 1 inch for maximum 3 inch thick insulation and 1¼ inches for insulation greater than 3 inches.	6 inches OC 3 inches from the center line on both sides of each major rib or in a 5-7-5-7 inch pattern with fasteners located 2½ inches from the center line on both sides of each major rib. Side lap fasteners spaced 20 inches OC.	<b>-52.5</b>
<b>Minimum 26 Gauge Steel PBR<sup>2</sup>, Maximum 36 inches wide</b>				<b>Class 90<sup>5,6</sup></b>
<b>62</b>	Minimum 2 pcf, 1 to 2¼ inch thick rigid insulation supplied in 4 foot wide sheets. Butt joints to occur over purlins. Top surface of all joints to be continuously sealed with a 2 inch wide vapor barrier tape.	No. 12-14 self-tapping, hex-head, plated steel screws with a separate ½ inch OD formed steel washer and a separate neoprene sealing washer. Length to be 1 inch for maximum 3 inch thick insulation and 1¼ inches for insulation greater than 3 inches.	12 inches OC between major ribs, end lap spacing in 4½-7½-4½-7½ inch pattern beginning 2½ inches from the center line on both sides of each major rib. Side lap fasteners to be 20 inches OC.	<b>-52.5</b>

<sup>1</sup>Non-decked, open framing construction

<sup>2</sup>Meets Class 4 Impact Rating

<sup>3</sup>Structural supports spaced maximum 63-¼ inches oc

<sup>4</sup>Structural supports minimum 13 MSG 55 ksi steel

<sup>5</sup>Structural supports minimum 16 MSG 50 ksi steel

<sup>6</sup>Structural supports spaced maximum 60 3/16 inches oc

**TABLE 3: WIND UPLIFT ASSEMBLIES<sup>1</sup> (continued)**

System Number	Insulation	Fasteners	Metal Panel Attachment	Allowable Uplift Pressure UL 580
<b>Minimum 26 Gauge Steel PBR<sup>2</sup>, Maximum 36 inches wide</b>				<b>Class 90<sup>3,4</sup></b>
<b>63</b>	(Optional) — Any compressible blanket insulation maximum 4 inches thick before compression or rigid 2¼ inch thick rigid insulation supplied in 4 foot wide sheets. Butt joints to occur over purlins. Top surface of all joints to be continuously sealed with a 2 in. wide vapor barrier tape.	No. 14 self-tapping, hex-head, plated steel or stainless steel screws with a separate ⅝ inch O.D. steel or aluminum washer and a separate neoprene sealing washer. No. 12-14 self-drilling, self-tapping, hex-head, plated steel stand-off screws with a separate ⅝ OD formed steel washer and a separate neoprene sealing washer. Min fastener length to be ⅞ inch longer than thickness of rigid insulation. Fasteners for panel to panel connections to be same as for compressible insulation.	6 inches OC 3 inches from the center line on both sides of each major rib or in a 5-7-5-7 inch pattern with fasteners located 2½ inches from the center line on both sides of each major rib all fastened into structural supports. Side lap fasteners spaced 20 inches OC.	<b>-52.5</b>
<b>64</b>	Optional- Any compressible blanket insulation, maximum 6 inches thick before compression.	No. 12-14 by 1 inch self-tapping, hex-head, plated steel screws with a separate ⅝ inch O.D. steel or aluminum washer and a separate neoprene sealing washer	12 inches O.C. beginning 2½ inches from center line on one side of each major rib. End lap spacing in 5—7—5—7 inch pattern beginning 2½ inches from the center line on both sides of each major rib all fastened into structural supports. <sup>5, 6</sup> Side lap fasteners maximum 20 inches O.C.	<b>-52.5</b>

<sup>1</sup>Non-decked, open framing construction

<sup>2</sup>Meets Class 4 Impact Rating

<sup>3</sup>Structural supports spaced maximum 60-¼ inches oc

<sup>5</sup>Structural supports spaced maximum 60 3/16 inches oc

<sup>4</sup>Structural supports minimum 16 MSG 55 ksi steel

<sup>6</sup>Structural supports minimum 16 MSG 50 ksi steel



**TABLE 3: WIND UPLIFT ASSEMBLIES<sup>1</sup> (continued)**

System Number	Insulation	Fasteners	Metal Panel Attachment	Allowable Uplift Pressure UL 580
<b>Minimum 26 Gauge Steel PBR<sup>2</sup>, Maximum 36 inches wide</b>				<b>Class 90</b>
<b>65</b>	Optional- Any compressible blanket insulation, maximum 4 inches thick before compression.	No. 14 self-tapping, hex-head, plated steel or stainless steel screws with a separate 5/8 inch O.D. steel or aluminum washer and a separate neoprene sealing washer	12 inches O.C. 2½ inches from the center line of each major rib and at end laps into minimum 16 MSG gauge steel purlins. <sup>3,4</sup> Side lap fasteners maximum 20 inches O.C.	<b>-52.5</b>
<b>66</b>	Compressible blanket type insulation 4 inches thick before compression.	No. 12-14 by 1¼ inches long self-drilling, self-tapping, hex-head plated steel screws with a separate ½ inch OD formed steel washer and a neoprene sealing washer.	12 in. OC beginning 2¼ inches from the center line on one side of each major rib and at end laps into minimum 16 MSG gauge steel purlins. <sup>3,4</sup> Side lap fasteners maximum 20 inches O.C.	<b>-52.5</b>
<b>67</b>	Optional- Any compressible blanket insulation, maximum 6 inches thick before compression.	No. 12-14 by 1 inch self-tapping, hex-head, plated steel screws with a separate 5/8 inch O.D. steel or aluminum washer and a separate neoprene sealing washer; lap screws are 1/4 in. -14 by 7/8 inch self-drilling, self-tapping, hex head, plated steel lap Tek with 5/8 inch O.D. steel washer and a neoprene sealing washer	12 inches O.C. beginning 2½ inches from center line on one side of each major rib. <sup>3,4</sup> End lap spacing in 5—7—5—7 inch pattern beginning 2½ inches from the center line on both sides of each major rib. Side lap fasteners maximum 20 inches O.C.	<b>-52.5</b>

<sup>1</sup>Non-decked, open framing construction

<sup>2</sup>Meets Class 4 Impact Rating

<sup>3</sup>Structural supports spaced maximum 60 3/16 inches oc

<sup>4</sup>Structural supports minimum 16 MSG 50 ksi steel

**TABLE 3: WIND UPLIFT ASSEMBLIES<sup>1</sup> (continued)**

System Number	Insulation	Fasteners	Metal Panel Attachment	Allowable Uplift Pressure UL 580
<b>Minimum 26 Gauge Steel PBR<sup>2</sup>, Maximum 36 inches wide</b>				<b>Class 90</b>
<b>68</b>	Optional- Any compressible blanket insulation, maximum 4 inches thick before compression.	No. 14 self-tapping, hex-head, plated steel or stainless steel screws with a separate 5/8 inch O.D. steel or aluminum washer and a separate neoprene sealing washer	12 inches O.C. 2½ inches from the center line of each major rib and at end laps into structural supports. <sup>3</sup> Side lap fasteners maximum 20 inches O.C.	<b>-52.5</b>
<b>Minimum 24 Gauge Steel PBR<sup>2</sup>, Maximum 16 inches wide</b>				<b>Class 90</b>
<b>69</b>	Optional- Any compressible blanket insulation, maximum 6 inches thick before compression.	No. 12-14 by 1 inch self-tapping, hex-head, plated steel screws with a separate 5/8 inch O.D. steel or aluminum washer and a separate neoprene sealing washer; lap screws are 1/4 in. -14 by 7/8 inch self-drilling, self-tapping, hex head, plated steel lap Tek with 5/8 inch O.D. steel washer and a neoprene sealing washer	12 inches O.C. beginning 2½ inches from center line on one side of each major rib and at End laps spaced 5—7—5—7 inch pattern into structural supports <sup>3,4</sup> beginning 2½ inches from the center line on both sides of each major rib. Side lap fasteners maximum 20 inches O.C.	<b>-52.5</b>

<sup>1</sup>Non-decked, open framing construction

<sup>2</sup>Meets Class 4 Impact Rating

<sup>3</sup>Structural supports spaced maximum 60 inches oc

<sup>4</sup>Structural supports minimum 16 MSG 40 ksi steel

**TABLE 3: WIND UPLIFT ASSEMBLIES<sup>1</sup> (continued)**

<b>System Number</b>	<b>Insulation</b>	<b>Fasteners</b>	<b>Metal Panel Attachment</b>	<b>Allowable Uplift Pressure UL 580</b>
<b>Minimum 24 Gauge Steel HR-34<sup>2</sup>, Maximum 36 inches wide</b>				<b>Class 90</b>
<b>70</b>	Optional- Any compressible blanket insulation, maximum 4 inches thick before compression.	No. 14, Type AB or BP, hex-head, self-tapping, stainless steel screws with a separate 5/8 inch stainless steel washer and a bonded neoprene sealing washer.	Fastened in every other valley 14 inches OC with a fastener located in upper panel at side lap and in every valley at end lap. <sup>3</sup>	<b>-52.5</b>
<b>71</b>	Optional- Any compressible blanket insulation, maximum 4 inches thick before compression.	No. 12-14 self-drilling, self-tapping, hex-head, plated steel, stand-off screws with a separate 5/8 in. OD formed steel washer and a neoprene sealing washer. Length to be 3¾ in. when 2 inch thick thermal spacers (Item 4) and compressible blanked insulation (Item 3) and used and 2-¾ inch when 1 inch thick thermal spacers are compressible insulation are used. When no thermal spacers are used No. 14 by min ¾ inch long self-drilling, self-tapping, hex-head, plated steel screws with 5/8 inch OD formed steel washer and an EPDM sealing washer to be used. No. 12-14 by 1 inch long self-drilling, self-tapping, hex-head plated steel screws with a separate ½ inch OD formed steel washer and a neoprene sealing washer for side laps.	7.2 inches OC into structural support <sup>4</sup> every valley and in end-laps. Side lap fasteners maximum 20 inches O.C.	<b>-52.5</b>
<b>Minimum 24 Gauge Steel HR-34, Maximum 36 inches wide</b>				<b>Class 30</b>
<b>72</b>	Optional- Any compressible blanket insulation, maximum 4 inches thick before compression.	No. 12-14 self-drilling, self-tapping, hex-head, plated steel, stand-off screws with a separate 5/8 inch OD formed steel washer and a neoprene sealing washer. Length to be 3¾ inch when 2 inch thick thermal spacers (Item 4) and compressible blanked insulation (Item 3) and used and 2-¾ inch when 1 inch thick thermal spacers are compressible insulation are used. When no thermal spacers are used No. 14 by min ¾ inch long self-drilling, self-tapping, hex-head, plated steel screws with 5/8 inch OD formed steel washer and an EPDM sealing washer to be used. No. 12-14 by 1 inch long self-drilling, self-tapping, hex-head plated steel screws with a separate ½ inch OD formed steel washer and a neoprene sealing washer for side laps.	14 inches OC in every other valley and 7.2 inches OC in end-laps into structural supports. <sup>4</sup> Side lap fasteners maximum 20 inches O.C.	<b>-15.0</b>

<sup>1</sup>Non-decked, open framing construction

<sup>2</sup>Meets Class 4 Impact Rating

<sup>3</sup>Structural supports minimum 16 MSG 33 ksi steel spaced maximum 63 inches oc

<sup>4</sup>Minimum 16 MSG structural supports spaced maximum 63¾ inches oc

**TABLE 4: WIND UPLIFT ASSEMBLIES<sup>1</sup>**

<b>System Number</b>	<b>Insulation</b>	<b>Metal Panel Attachment</b>	<b>Allowable Uplift Pressure UL 580</b>
<b>Minimum 24 Gauge Steel MS-200<sup>2</sup>, Maximum 18 inches wide</b>			<b>Class 90</b>
<b>73</b>	Minimum 5 inch thick structural cement fiber unit consisting of minimum 0.95 pcf expanded polystyrene foamed plastic core laminated to 7/16 inch thick OSB structural panels between supports <sup>3</sup>	(2) Minimum ¼-14 x 1 hex washer head screws spaced 24 inches oc	<b>-52.5</b>
<b>74</b>	Minimum 5 inch thick structural cement fiber unit consisting of minimum 0.95 pcf expanded polystyrene foamed plastic core laminated to 7/16 inch thick OSB structural panels between supports <sup>3</sup>	(2) Minimum No. 10-12 x 1 inch pancake head screws spaced 36 inches oc	<b>-52.5</b>
<b>Minimum .032 Aluminum Versa Span<sup>2</sup>, Maximum 16 inches wide</b>			<b>Class 90</b>
<b>75</b>	Minimum 5 inch thick structural cement fiber unit consisting of minimum 0.95 pcf expanded polystyrene foamed plastic core laminated to 7/16 inch thick OSB structural panels between supports <sup>3</sup>	(2) Minimum No. 10-12 x 1 inch pancake head screws spaced 18 inches oc	<b>-52.5</b>

<sup>1</sup>These assemblies comply with UL790 (ASTM E108) for Class A fire performance at an unlimited slope

<sup>2</sup>Meets Class 4 Impact Rating

<sup>3</sup>Rabbeted into truss tees spaced maximum 48 inches oc or over structural supports spaced according to design specifications

**TABLE 5: FACTORY MUTUAL CLASS 1 A FIRE RATED WIND UPLIFT ASSEMBLIES**

System Number	FM Approved Deck	Insulation	Metal Panel/Clip Attachment	Allowable Uplift Pressure FM 4471
<b>Minimum 24 Gauge Steel MS-200<sup>1</sup>, Maximum 16 inches wide</b>				<b>Class 1-120</b>
<b>76</b>	Minimum 33 ksi steel <sup>2, 3</sup>	Any UL Listed standard density Polyisocyanurate roofing insulation board, minimum 2 inches thick	MS-200 Float Clip 24 inches oc. Clip rows staggered 6 inches oc. Each clip is placed over a MS-200 Bearing Plate secured to the deck with (2) SFS Intec Deckfast DF-#14-PH3 fasteners.	<b>-60</b>

<sup>1</sup>Class A rating for combustibility from above the roof deck at 5 in 12 slope. Severe Hail (SH) rated for hail and Foot Traffic Resistant

<sup>2</sup>Deck side laps fastened with ITW #10 HWH TEKS 1 6 inches oc

<sup>3</sup>Steel deck fastened with ITW #12 HWH TEKS 5 paced 6 inches oc into minimum ¼ inch thick steel supports spaced maximum 60 inches oc

System Number	Structural Supports	Metal Panel Attachment	Allowable Uplift Pressure FM 4471
<b>Minimum 24 Gauge Steel MS-200<sup>1</sup>, Maximum 16 inches wide</b>			<b>Class 1-75</b>
<b>77</b>	Minimum 16 gauge 50 ksi steel purlins spaced maximum 60 inches oc	MS-200 Float Clip 60 inches oc. Clip rows staggered 6 inches oc. Each clip secured to the purlin deck with (2) ¼-14 x length Blazer 3, 5/16" HWH Tri-Seal Coated Self-Drilling Tapping Screw.	<b>-37.5</b>

<sup>1</sup>Class A rating for combustibility from above the roof deck at 5 in 12 slope. Severe Hail (SH) rated for hail and Foot Traffic Resistant

**TABLE 6: ASTM E1592 LOAD SPAN DATA**

<b>MS-200 Aluminum, single lock</b>									
Gage Thickness	Panel Width (inches)	Yield Strength (ksi)	Fastener Spacing (feet), Allowable Load						
			1	1.5	2	2.5	3	3.5	4
0.032	18	19	36.4	32.5	28.6	24.7	20.8	16.9	13.0
0.040	18	19	46.9	42.6	38.2	33.4	29.5	25.2	20.8

<b>MS-200 Aluminum, double lock</b>											
Gage Thickness	Panel Width (inches)	Yield Strength (ksi)	Fastener Spacing (feet), Allowable Load (psf)								
			1	1.5	2	2.5	3	3.5	4	4.5	5
0.032	18	19	83.3	77.4	71.5	65.7	59.8	54.0	48.1	42.3	36.4

<b>MS-200 Steel, double lock</b>											
Gage Thickness	Panel Width (inches)	Yield Strength (ksi)	Fastener Spacing (feet), Allowable Load								
			1	1.5	2	2.5	3	3.5	4	4.5	5
24	16	50	161.3	147.6	134.0	120.3	106.7	93.0	79.4	67.7	52.1
22	16	50	163.9	150.9	137.9	124.9	111.9	98.9	85.9	72.9	59.9
24	18	50	109.3	101.1	93.0	84.9	76.7	68.6	60.5	52.3	44.2
22	18	50	156.1	143.4	130.7	118.0	105.4	92.7	80.0	67.3	54.7

<b>MS-200 Steel, single lock</b>										
Gage Thickness	Panel Width (inches)	Yield Strength (ksi)	Fastener Spacing (feet), Allowable Load (psf)							
			1	1.5	2	2.5	3	3.5	4	
24	18	50	59.9	53.4	46.9	40.4	33.8	27.3	20.8	
22	18	50	98.9	88.1	77.2	66.4	55.5	44.7	33.8	

<sup>1</sup>Fasteners specified as per the manufacturer's installation instructions

<sup>2</sup>Load span values derived from ultimate load in ASTM E1592 tests and Allowable Stress Design

<sup>3</sup>Allowable loads employ a safety factor of 2.0 when compared with the tested value

<sup>4</sup>Allowable loads cannot be increased by 1/8" and do not consider self-weight of the panel or clip fastener connection resistance

**TABLE 6: ASTM E1592 LOAD SPAN DATA (continued)**

<b>VersaSpan Aluminum</b>									
Gage Thickness	Panel Width (inches)	Yield Strength (ksi)	Fastener Spacing (feet), Allowable Load (psf)						
			1	1.5	2	2.5	3	3.5	4
0.032	16	19	46.8	42.4	38.1	33.8	29.4	25.1	20.8
0.032	18	19	54.6	48.5	42.4	36.4	30.3	24.2	18.2

<b>VersaSpan Steel</b>									
Gage Thickness	Panel Width (inches)	Yield Strength (ksi)	Fastener Spacing (feet), Allowable Load (psf)						
			1	1.5	2	2.5	3	3.5	4
24	16	50	83.2	73.6	64.1	54.6	45.0	35.5	26.0
22	16	50	93.6	87.1	78.0	68.9	59.8	50.7	41.6
24	18	50	67.6	59.8	52.0	44.2	36.4	28.6	20.8
22	18	50	90.1	79.8	69.6	59.3	49.1	38.8	28.6

<b>PBR/Marion R Steel, six screws</b>									
Gage Thickness	Panel Width (inches)	Yield Strength (ksi)	Fastener Spacing (feet), Allowable Load (psf)						
			2	2.5	3	3.5	4	4.5	5
26	36	80	100.0	92.5	85.0	77.5	70.0	62.5	55.0
24	36	50	175.0	156.7	138.3	120.0	101.7	83.3	65.0
22	36	50	200.0	178.3	156.7	135.0	113.3	91.7	70.0

<b>PBR/Marion R Aluminum, six screws</b>									
Gage Thickness	Panel Width (inches)	Yield Strength (ksi)	Fastener Spacing (feet), Allowable Load (psf)						
			2	2.5	3	3.5	4	4.5	5
0.032	36	19	187.5	165.5	143.3	121.3	99.2	77.1	55.0

<sup>1</sup>Fasteners specified as per the manufacturer's installation instructions

<sup>2</sup>Load span values derived from ultimate load in ASTM E1592 tests and Allowable Stress Design

<sup>3</sup>Allowable loads employ a safety factor of 2.0 when compared with the tested value

<sup>4</sup>Allowable loads cannot be increased by 1/3 and do not consider self-weight of the panel or fastener resistance

**TABLE 6: ASTM E1592 LOAD SPAN DATA (continued)**

<b>MS-150 Steel, single lock</b>									
<b>Gage Thickness</b>	<b>Panel Width (inches)</b>	<b>Yield Strength (ksi)</b>	<b>Fastener Spacing (feet), Allowable Load</b>						
			<b>1</b>	<b>1.5</b>	<b>2</b>	<b>2.5</b>	<b>3</b>	<b>3.5</b>	<b>4</b>
24	16¾	50	13.0	12.1	11.3	10.4	9.5	8.7	7.8
22	16¾	50	57.3	50.4	43.4	36.5	29.5	22.6	15.6

<b>MS-150 Steel, double lock</b>									
<b>Gage Thickness</b>	<b>Panel Width (inches)</b>	<b>Yield Strength (ksi)</b>	<b>Fastener Spacing (feet), Allowable Load (psf)</b>						
			<b>1</b>	<b>1.5</b>	<b>2</b>	<b>2.5</b>	<b>3</b>	<b>3.5</b>	<b>4</b>
24	12-5/8	50	137.9	124	110.2	96.3	82.4	68.6	54.7
22	12	50	182.2	161.8	141.4	121.1	100.7	80.3	59.9
24	16-5/8	50	119.7	107.1	94.5	81.9	69.4	56.8	44.2
22	16-5/8	50	145.7	128.8	111.9	95.0	78.0	61.1	44.2
24	18	50	109.3	97.1	85.0	72.8	60.7	48.5	36.4
22	18	50	124.9	111.5	98.0	84.6	71.1	57.7	44.2

<b>MS-150 Aluminum, single lock</b>									
<b>Gage Thickness</b>	<b>Panel Width (inches)</b>	<b>Yield Strength (ksi)</b>	<b>Fastener Spacing (feet), Allowable Load</b>						
			<b>1</b>	<b>1.5</b>	<b>2</b>	<b>2.5</b>	<b>3</b>	<b>3.5</b>	<b>4</b>
0.032	16¾	19	36.4	32.5	28.6	24.7	20.8	16.9	13.0

<b>MS-150 Aluminum, double lock</b>									
<b>Gage Thickness</b>	<b>Panel Width (inches)</b>	<b>Yield Strength (ksi)</b>	<b>Fastener Spacing (feet), Allowable Load (psf)</b>						
			<b>1</b>	<b>1.5</b>	<b>2</b>	<b>2.5</b>	<b>3</b>	<b>3.5</b>	<b>4</b>
0.032	12-5/8	19	111.9	100.1	88.4	76.7	65	53.3	41.6
0.032	18	19	83.3	73.7	64.2	54.6	45.1	35.5	26.0

<sup>1</sup>Fasteners specified as per the manufacturer's installation instructions

<sup>2</sup>Load span values derived from ultimate load in ASTM E1592 tests and Allowable Stress Design

<sup>3</sup>Allowable loads employ a safety factor of 2.0 when compared with the tested value

<sup>4</sup>Allowable loads cannot be increased by 1/3 and do not consider self-weight of the panel or clip fastener connection resistance



**TABLE 6: ASTM E1592 LOAD SPAN DATA (continued)**

<b>Classic 7/8" Corrugated Steel, seven screws</b>									
<b>Gage Thickness</b>	<b>Panel Width (inches)</b>	<b>Yield Strength (ksi)</b>	<b>Fastener Spacing (feet), Allowable Load (psf)</b>						
			<b>2</b>	<b>2.5</b>	<b>3</b>	<b>3.5</b>	<b>4</b>	<b>4.5</b>	<b>5</b>
26	36	80	162.5	162.5	162.5	162.5	162.5	162.5	162.5
24	36	50	162.5	108.3	99.2	90.0	80.8	71.7	75.0
22	36	50	175.0	135.4	120.8	106.3	91.7	77.1	75.0

<b>Classic 7/8" Corrugated Aluminum, seven screws</b>									
<b>Gage Thickness</b>	<b>Panel Width (inches)</b>	<b>Yield Strength (ksi)</b>	<b>Fastener Spacing (feet), Allowable Load (psf)</b>						
			<b>2</b>	<b>2.5</b>	<b>3</b>	<b>3.5</b>	<b>4</b>	<b>4.5</b>	<b>5</b>
0.032	36	19	175.0	155.0	135.0	115.0	95.0	75.0	55.0

<b>Classic 7/8" Corrugated Steel, five screws</b>									
<b>Gage Thickness</b>	<b>Panel Width (inches)</b>	<b>Yield Strength (ksi)</b>	<b>Fastener Spacing (feet), Allowable Load (psf)</b>						
			<b>2</b>	<b>2.5</b>	<b>3</b>	<b>3.5</b>	<b>4</b>	<b>4.5</b>	<b>5</b>
26	36	80	110.0	100.4	90.8	81.3	71.7	62.1	52.5
24	36	50	117.5	108.3	99.2	90.0	80.8	71.7	62.5
22	36	50	150.0	135.4	120.8	106.3	91.7	77.1	62.5

<b>Classic 7/8" Corrugated Aluminum, five screws</b>									
<b>Gage Thickness</b>	<b>Panel Width (inches)</b>	<b>Yield Strength (ksi)</b>	<b>Fastener Spacing (feet), Allowable Load (psf)</b>						
			<b>2</b>	<b>2.5</b>	<b>3</b>	<b>3.5</b>	<b>4</b>	<b>4.5</b>	<b>5</b>
0.032	36	19	55.0	50.8	46.7	42.5	38.3	34.2	30.0

<sup>1</sup>Fasteners specified as per the manufacturer's installation instructions

<sup>2</sup>Load span values derived from ultimate load in ASTM E1592 tests and Allowable Stress Design

<sup>3</sup>Allowable loads employ a safety factor of 2.0 when compared with the tested value

<sup>4</sup>Allowable loads cannot be increased by 1/3 and do not consider self-weight of the panel or fastener resistance

**TABLE 6: ASTM E1592 LOAD SPAN DATA (continued)**

<b>BR-36 Aluminum, five screws</b>									
Gage Thickness	Panel Width (inches)	Yield Strength (ksi)	Fastener Spacing (feet), Allowable Load (psf)						
			2	2.5	3	3.5	4	4.5	5
0.032	36	19	135.0	122.7	110.3	98.0	85.7	73.3	61.0
0.040	36	19	171.0	150.8	130.7	110.5	90.3	70.2	50.0

<b>BR-36 Steel, five screws</b>									
Gage Thickness	Panel Width (inches)	Yield Strength (ksi)	Fastener Spacing (feet), Allowable Load (psf)						
			2	2.5	3	3.5	4	4.5	5
24	36	50	200.0	179.2	158.3	137.5	116.7	95.8	75.0
22	36	50	200.0	180.0	160.0	140.0	120.0	100.0	80.0
20	36	33	170.0	153.1	136.2	119.3	102.3	85.4	68.5

<b>BR-36 Steel, three screws</b>									
Gage Thickness	Panel Width (inches)	Yield Strength (ksi)	Fastener Spacing (feet), Allowable Load (psf)						
			2	2.5	3	3.5	4	4.5	5
24	36	50	137.5	122.1	106.7	91.3	75.8	60.4	45.0
22	36	50	100.0	90.0	80.0	70.0	60.0	50.0	40.0
20	36	33	100.0	89.8	79.7	69.5	59.3	49.2	39.0

<b>BR-36 Aluminum, three screws</b>									
Gage Thickness	Panel Width (inches)	Yield Strength (ksi)	Fastener Spacing (feet), Allowable Load (psf)						
			2	2.5	3	3.5	4	4.5	5
0.032	36	19	55.0	51.7	48.3	45.0	41.7	38.3	35.0
0.040	36	19	75.0	69.2	63.3	57.5	51.7	45.8	40.0

<sup>1</sup>Fasteners specified as per the manufacturer's installation instructions

<sup>2</sup>Load span values derived from ultimate load in ASTM E1592 tests and Allowable Stress Design

<sup>3</sup>Allowable loads employ a safety factor of 2.0 when compared with the tested value

<sup>4</sup>Allowable loads cannot be increased by 1/3 and do not consider self-weight of the panel or fastener resistance

**TABLE 6: ASTM E1592 LOAD SPAN DATA (continued)**

<b>HR34 Steel, five screws</b>									
<b>Gage Thickness</b>	<b>Panel Width (inches)</b>	<b>Yield Strength (ksi)</b>	<b>Fastener Spacing (feet), Allowable Load (psf)</b>						
			<b>2</b>	<b>2.5</b>	<b>3</b>	<b>3.5</b>	<b>4</b>	<b>4.5</b>	<b>5</b>
26	34	80	175.0	157.5	140.0	122.5	105.0	87.5	70.0
24	34	50	200.0	180.0	160.0	140.0	120.0	100.0	80.0
22	34	50	200.0	178.3	156.7	135.0	113.3	91.7	70.0
20	34	33	200.0	179.2	158.3	137.5	116.7	95.8	75.0

<b>HR34 Aluminum, five screws</b>									
<b>Gage Thickness</b>	<b>Panel Width (inches)</b>	<b>Yield Strength (ksi)</b>	<b>Fastener Spacing (feet), Allowable Load (psf)</b>						
			<b>2</b>	<b>2.5</b>	<b>3</b>	<b>3.5</b>	<b>4</b>	<b>4.5</b>	<b>5</b>
0.032	34	19	120.0	108.3	96.7	85.0	73.3	61.7	50.0
0.040	34	19	200.0	177.1	154.2	131.3	108.3	85.4	62.5

<b>HR34 Aluminum, three screws</b>									
<b>Gage Thickness</b>	<b>Panel Width (inches)</b>	<b>Yield Strength (ksi)</b>	<b>Fastener Spacing (feet), Allowable Load (psf)</b>						
			<b>2</b>	<b>2.5</b>	<b>3</b>	<b>3.5</b>	<b>4</b>	<b>4.5</b>	<b>5</b>
0.032	34	19	112.5	100.8	89.7	78.5	67.3	56.2	45.0
0.040	34	19	100.0	90.0	80.0	70.0	60.0	50.0	40.0

<b>HR34 Steel, three screws</b>									
<b>Gage Thickness</b>	<b>Panel Width (inches)</b>	<b>Yield Strength (ksi)</b>	<b>Fastener Spacing (feet), Allowable Load (psf)</b>						
			<b>2</b>	<b>2.5</b>	<b>3</b>	<b>3.5</b>	<b>4</b>	<b>4.5</b>	<b>5</b>
26	34	80	87.5	80.4	73.3	66.3	59.2	52.1	45.0
24	34	50	100.0	90.8	81.7	72.5	63.3	54.2	45.0
22	34	50	100.0	90.8	81.7	72.5	63.3	54.2	45.0
20	34	33	105.0	95.8	86.7	77.5	68.3	59.2	50.0

<sup>1</sup>Fasteners specified as per the manufacturer's installation instructions

<sup>2</sup>Load span values derived from ultimate load in ASTM E1592 tests and Allowable Stress Design

<sup>3</sup>Allowable loads employ a safety factor of 2.0 when compared with the tested value

<sup>4</sup>Allowable loads cannot be increased by 1/3 and do not consider self-weight of the panel or fastener resistance

# Easy-Lock Detail

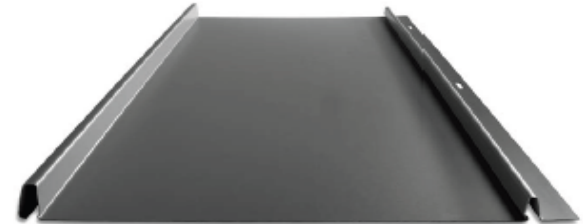
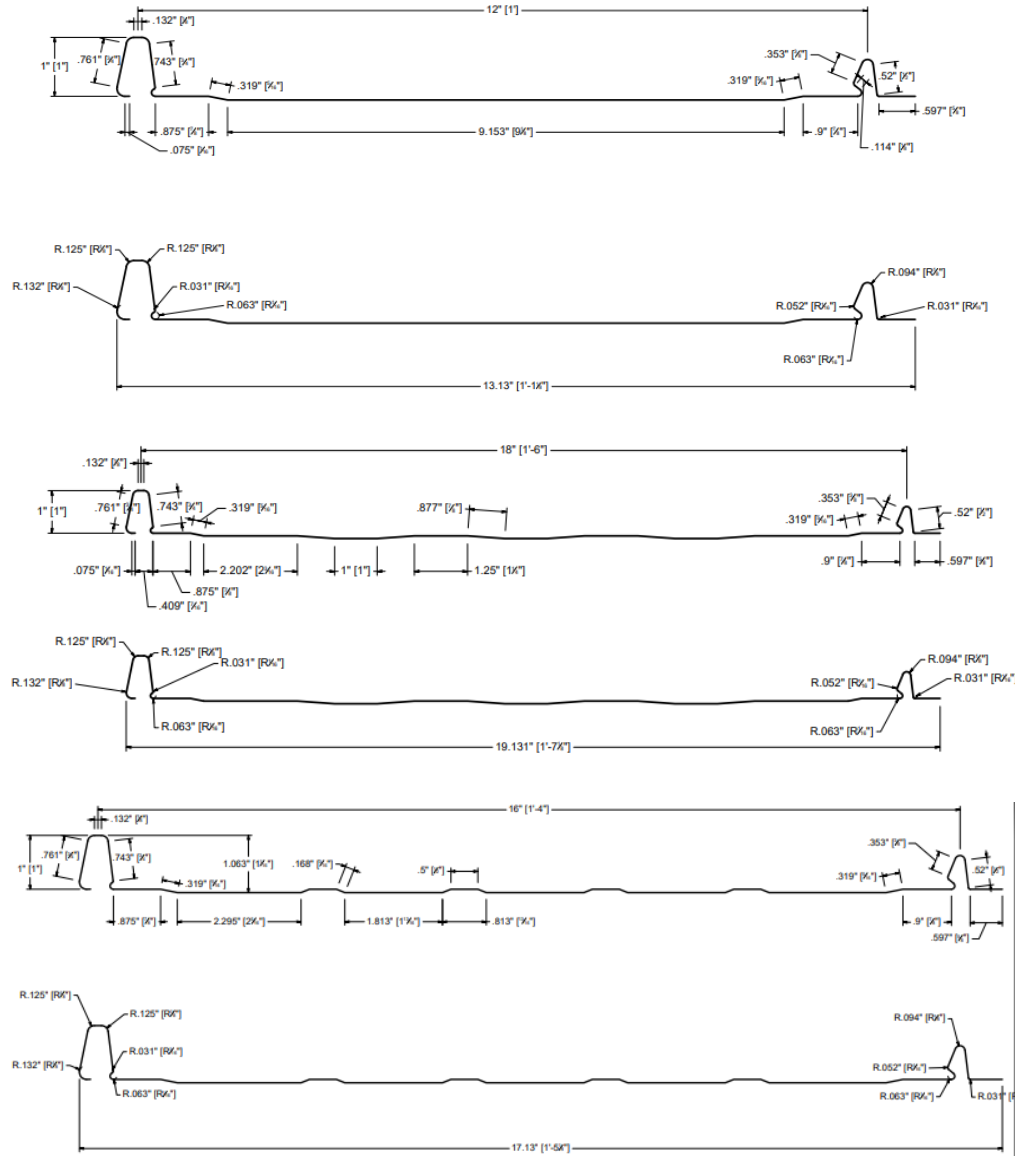

**FLAT PAN**



**STRIATED**

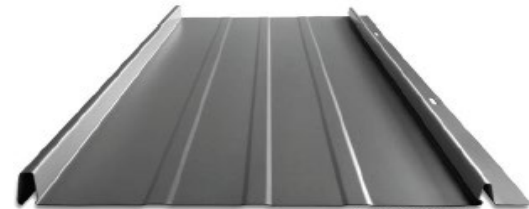

**ACCENT RIBS**  
 3 Accent ribs for 12" panel  
 4 Accent ribs for 16" & 18" panel

## Versa-Span Detail

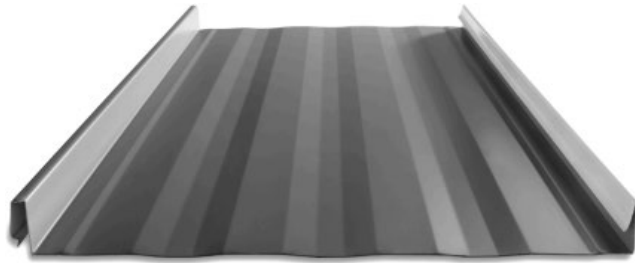

STRIATED

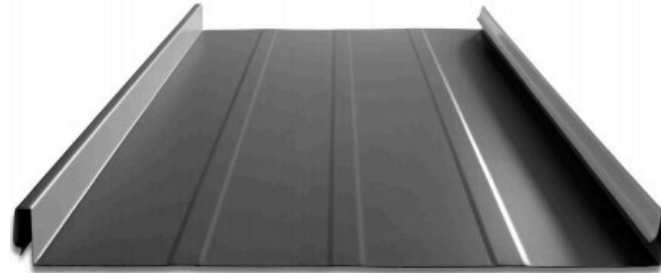

ACCENT RIBS  
 2 Accent ribs for 12" to 14 1/4" panel  
 3 Accent ribs for 16" to 18" panel



FLAT PAN

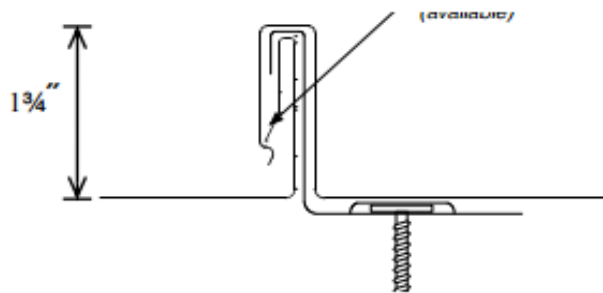

18 gauge Galv.

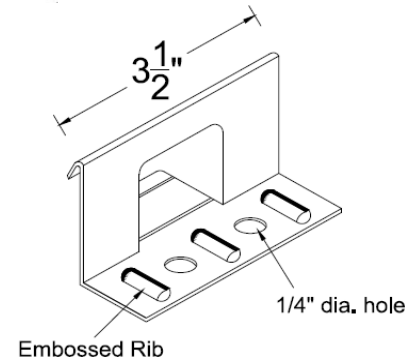
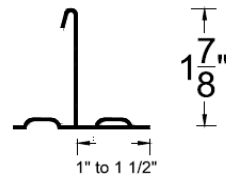

**MS-100,  
MS-150 Detail**

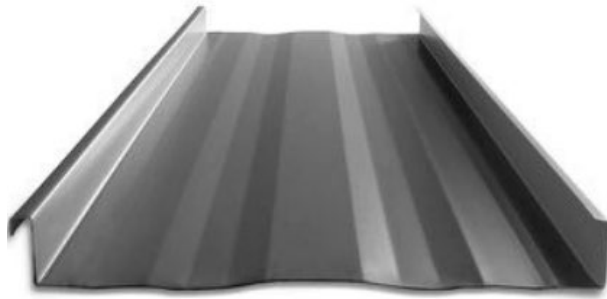

STRIATED

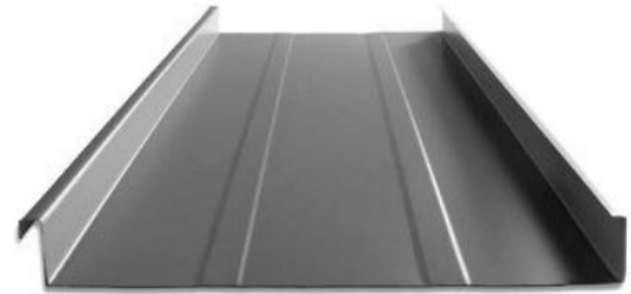

ACCENT RIBS



100-FC-28-S-118PF



FLAT PAN

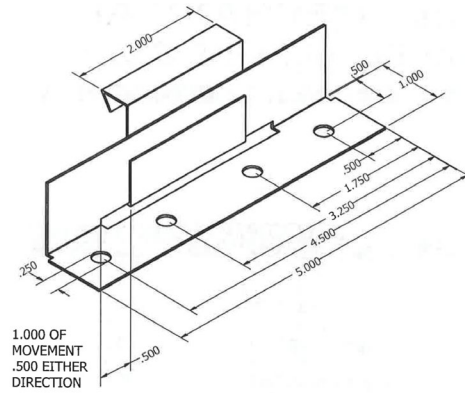
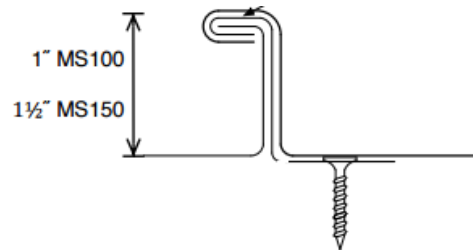
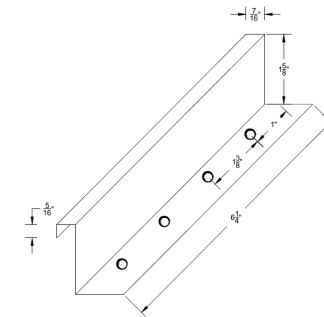

**Premier-Lock Detail**

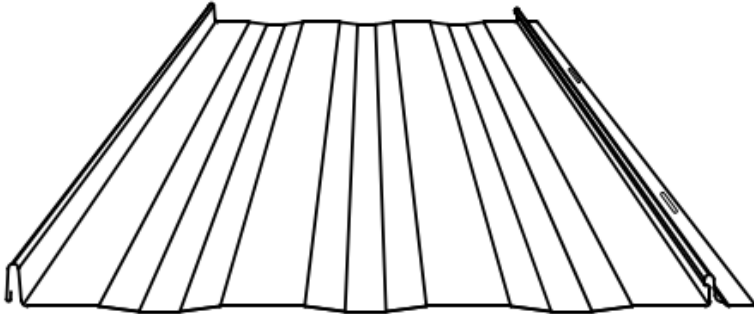

STRIATED

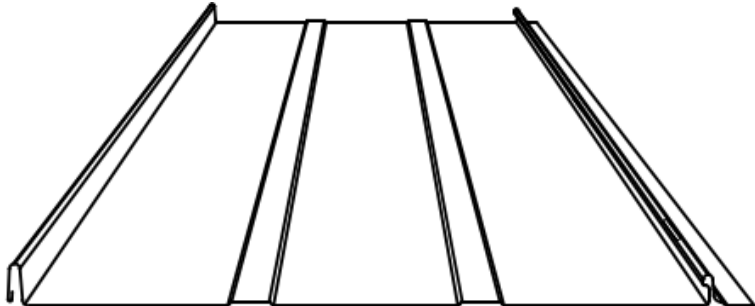

ACCENT RIBS

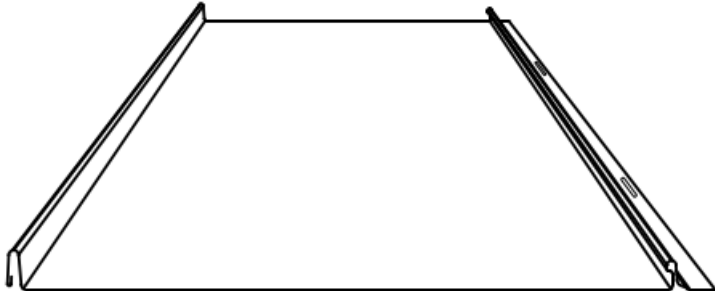

FLAT PAN

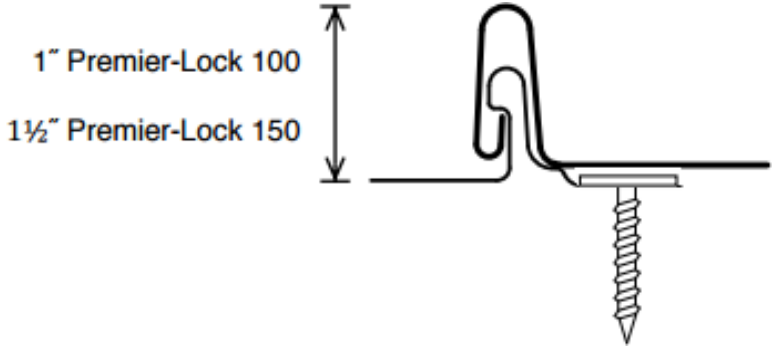

**Clip-Lock Detail**

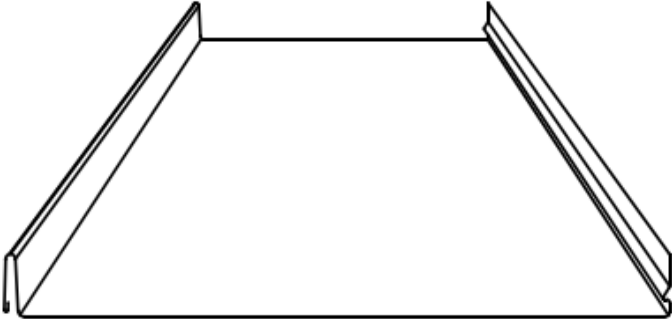
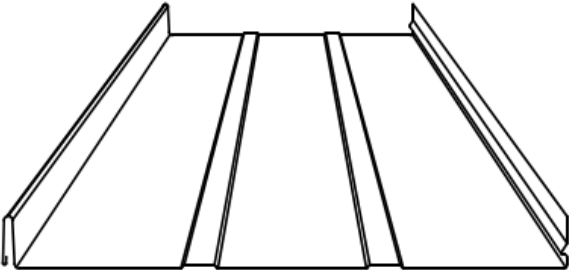
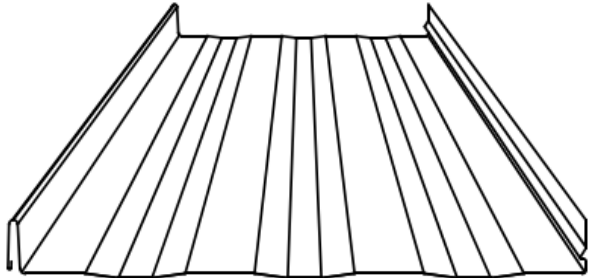

FLAT PAN

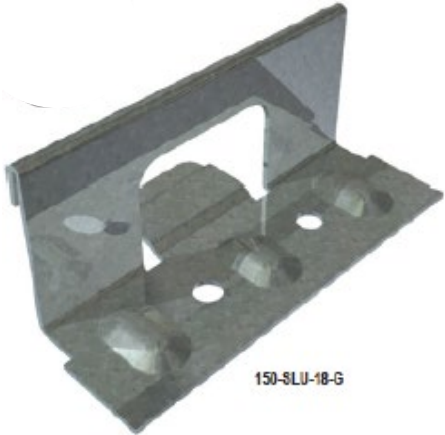

150-SLU-18-G

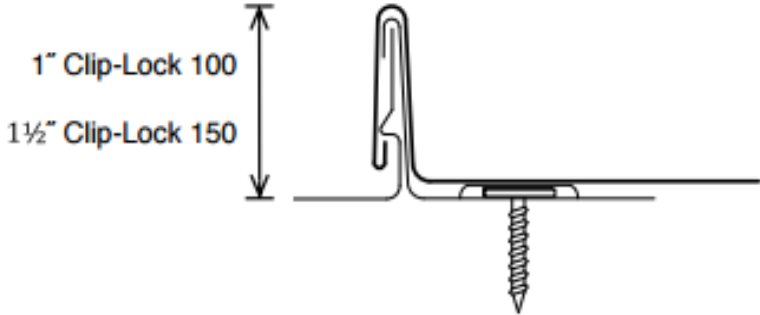



**MS-200 Detail**

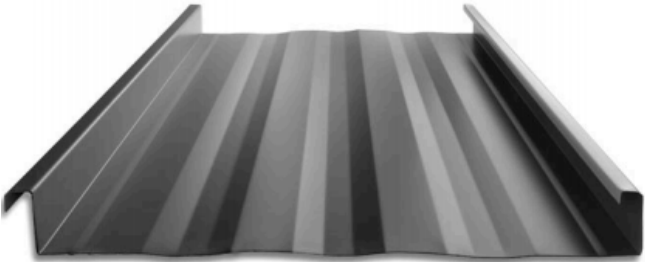

STRIATED

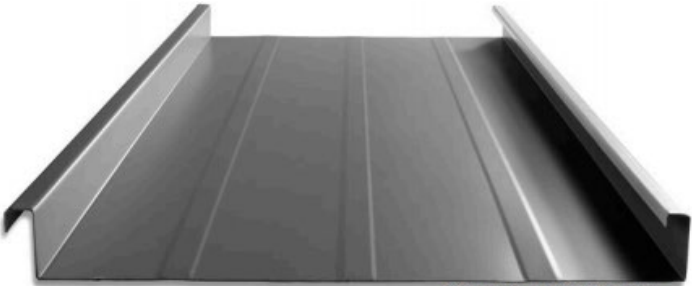

ACCENT RIBS  
 2 Accent ribs for 12" to 14 1/4" panel  
 3 Accent ribs for 16" to 18" panel

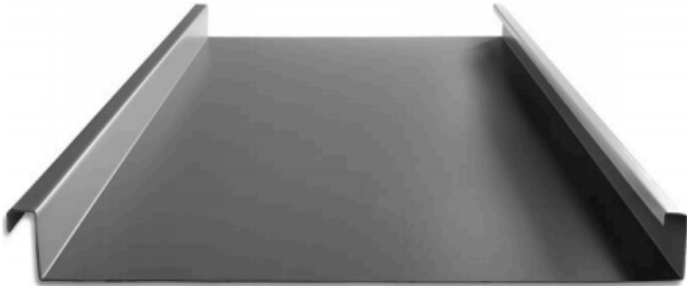

FLAT PAN

**90° SEAM DETAIL**

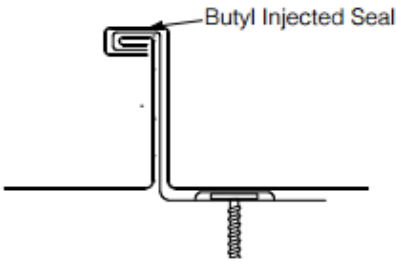

**180° SEAM DETAIL**

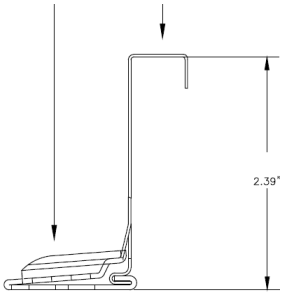
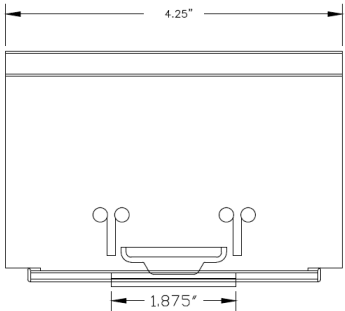
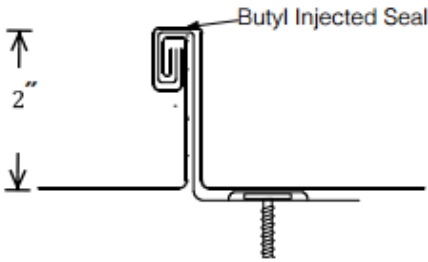

### T Panel Narrow Batten Detail

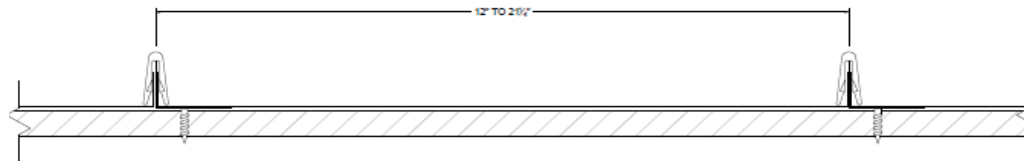
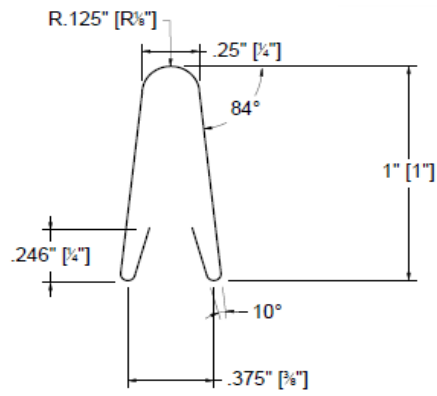
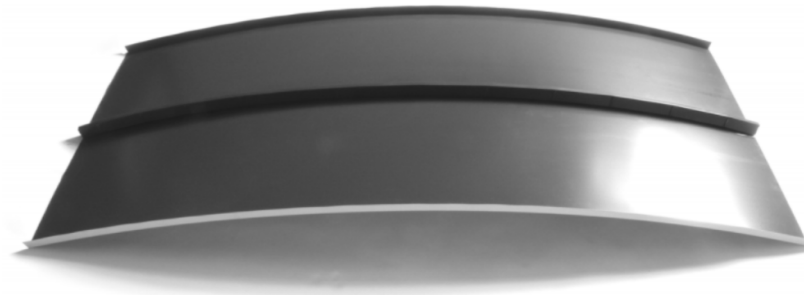

### PBR/Marion R Detail

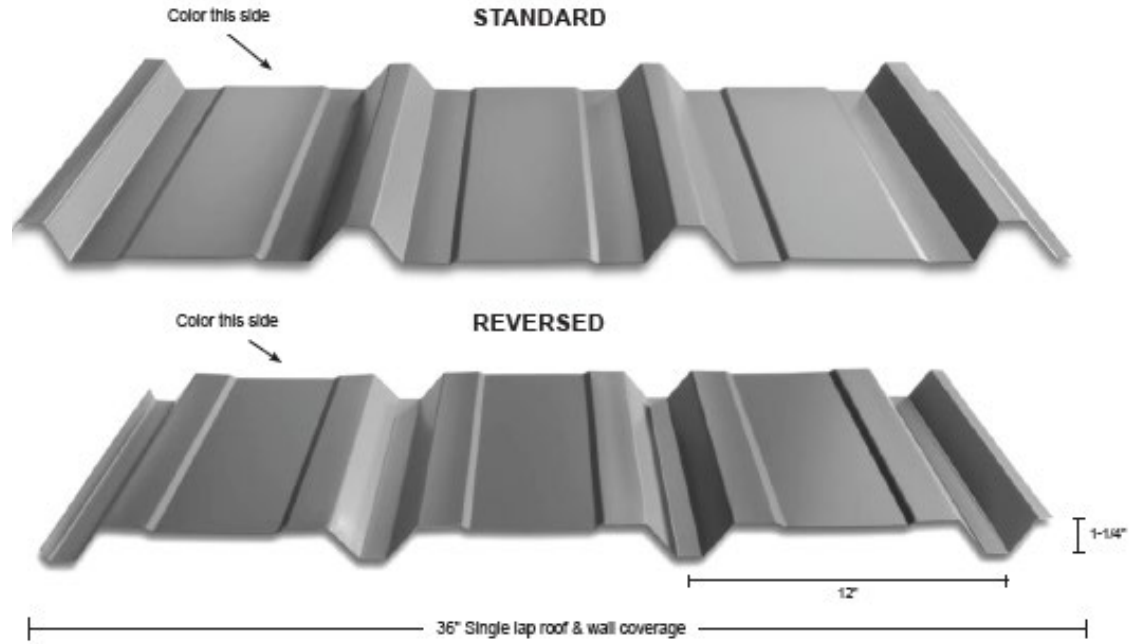

### STANDARD LAP DETAIL

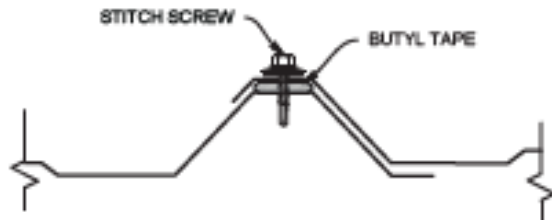

### REVERSE LAP DETAIL

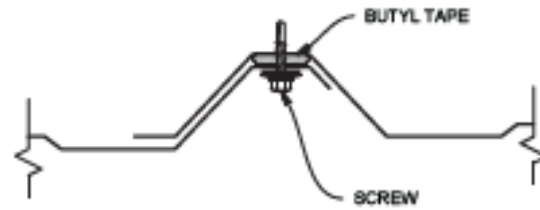

### Classic 7/8" Corrugated Detail

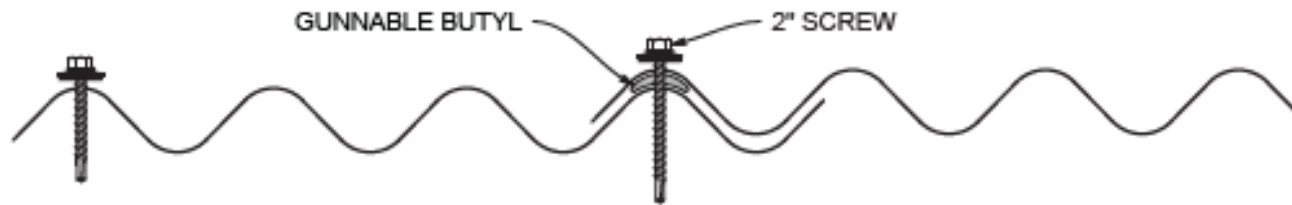
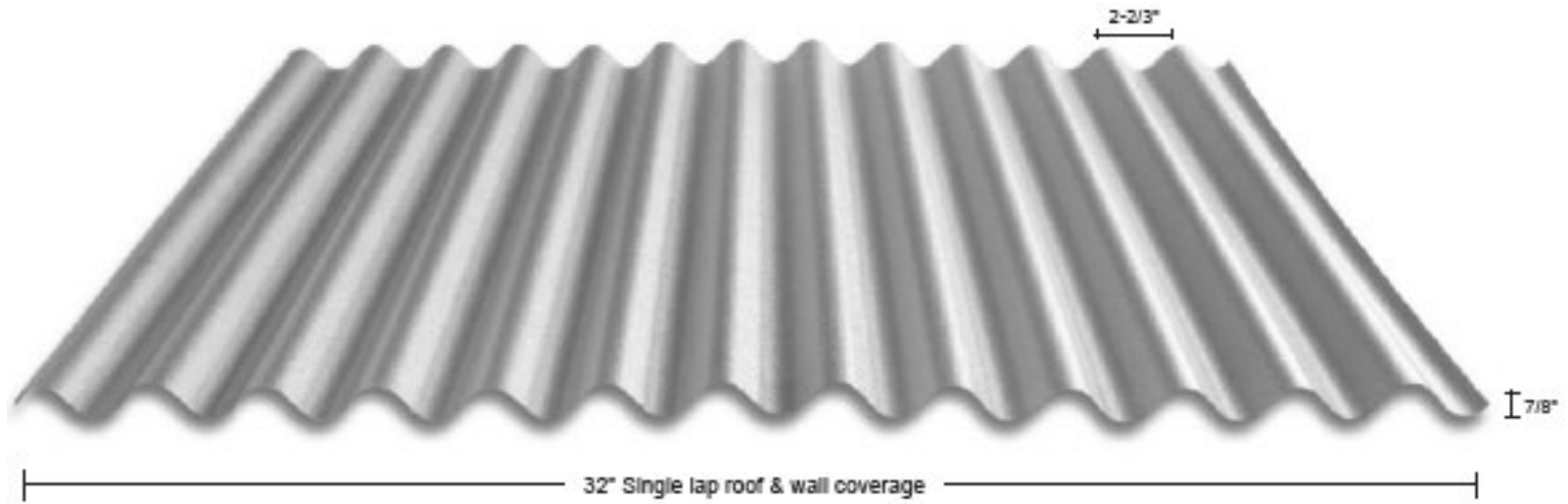

**HR-34 Detail**

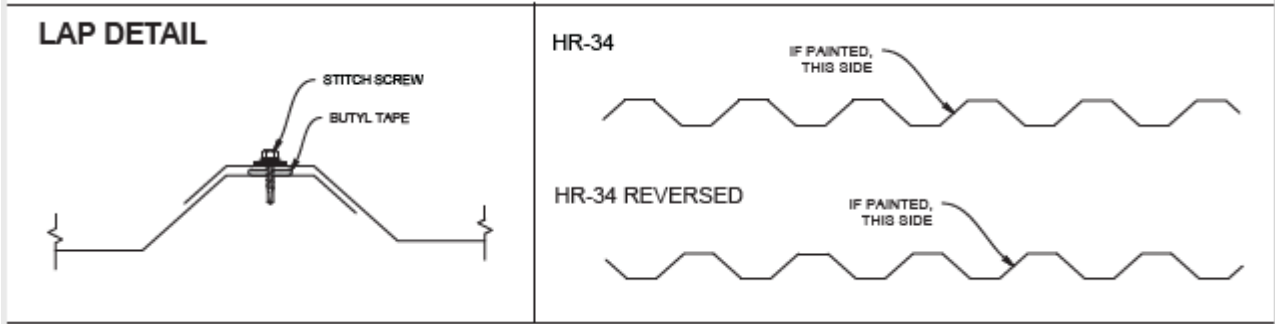
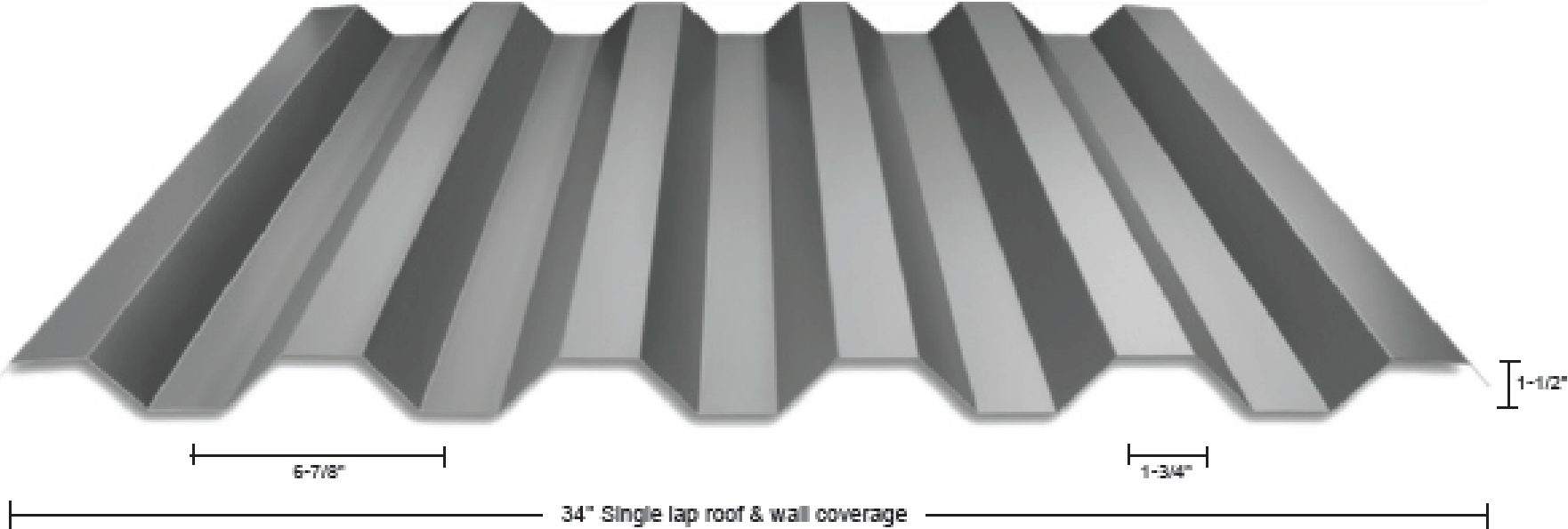

**BR-36 Detail**

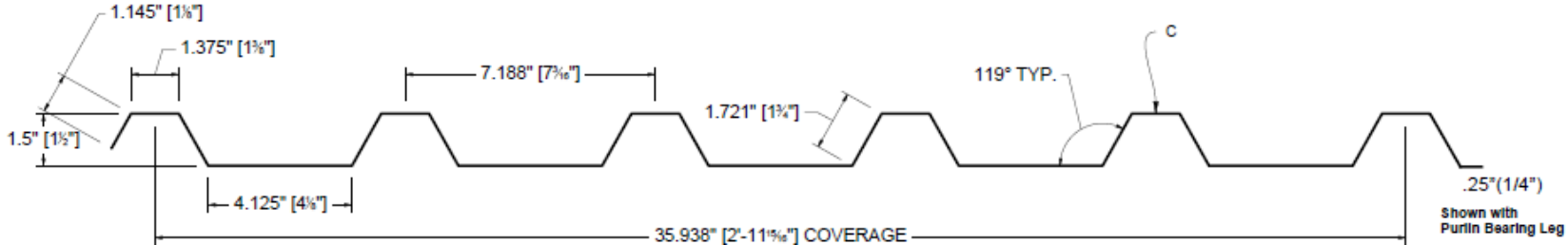
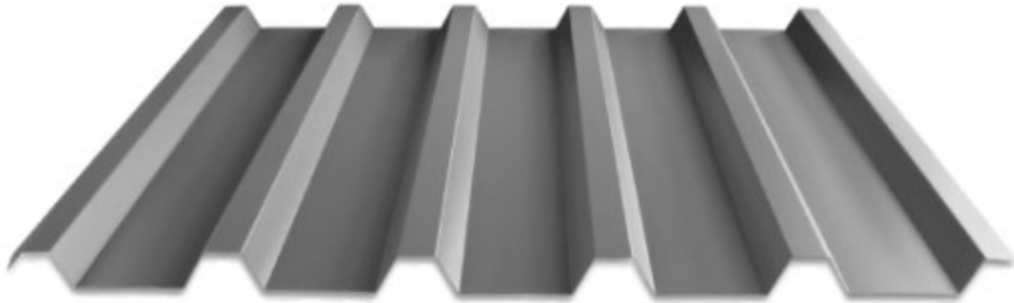

**LAP DETAIL**

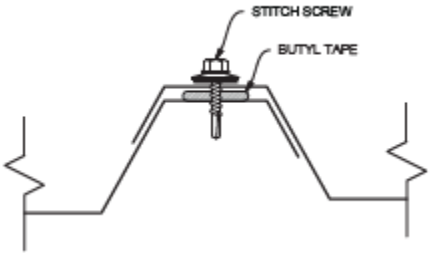

© 2023 UL LLC

*This UL Solutions Evaluation Report is not an endorsement or recommendation for use of the subject and/or product described herein. This Report is not the UL Solutions Listing or UL Solutions Classification Report that covers the subject product. The subject product's UL Solutions Listing or UL Solutions Classification is covered under a separate UL Solutions Report. UL Solutions disclaims all representations and warranties whether express or implied, with respect to this Report and the subject or product described herein. Contents of this Report may be based on data that has been generated by laboratories other than UL Solutions that are accredited as complying with ISO/IEC Standard 17025 by the International Accreditation Service (IAS) or by any other accreditation body that is a signatory to the International Laboratory Accreditation Cooperation (ILAC) Mutual Recognition Arrangement (MRA). The scope of the laboratory's accreditation shall include the specific type of testing covered in the test Report. As the accuracy of any non-UL Solutions data is the responsibility of the accredited laboratory, UL Solutions does not accept responsibility for the accuracy of this data.*

UL Solutions Headquarters  
333 Pfingsten Road  
Northbrook, IL 60062-2096 USA  
T: 847.272.8800  
[UL.com/Solutions](http://UL.com/Solutions)