

Company Name: _____
 Contact Name: _____
 Address: _____
 City/State/Zip: _____
 Phone: _____ Fax: _____
 Email: _____
 Project Name: _____
 Building Owner: _____
 Project Address: _____
 City/State/Zip: _____
 Phone: _____ Fax: _____

Ship To (Company Name): _____
 C/O (If different than above): _____
 Delivery Contact: _____
 Phone: _____
 Address: _____
 City/State/Zip: _____
 Required Delivery Date: _____
 OverEZee Quantity (LF): _____ (per your take-off)
 Area Wind Speed per code: _____ mph
 Type of Quote: Components Only Engineered

SELECT PANEL PROFILE AND FILL IN CRITICAL DIMENSIONS BELOW
 These dimensions are essential for us to quote and/or fabricate OverEZees correctly for you!

CHECK BOX BELOW TO SELECT APPROPRIATE EXISTING PANEL PROFILE

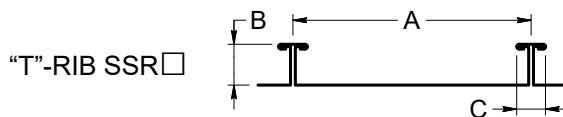
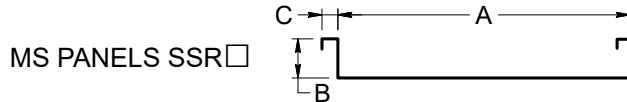
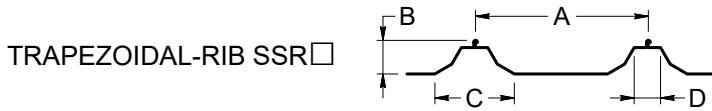
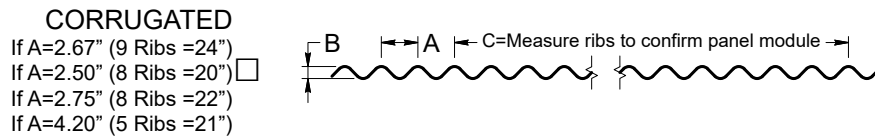
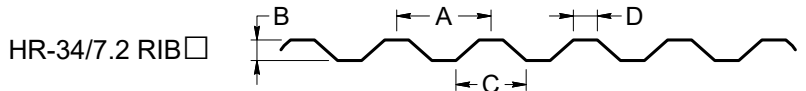
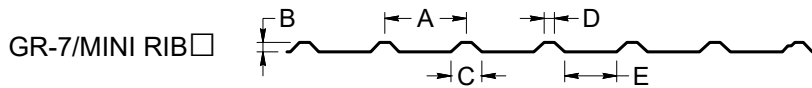
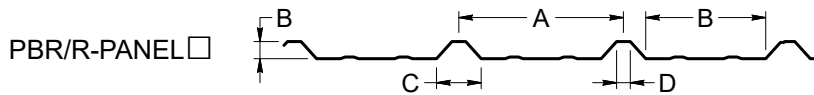

PROVIDE CORRESPONDING DIMENSIONS AS SHOWN AT LEFT FOR SELECTED PROFILE

A = _____
 B = _____
 C = _____
 D = _____
 E = _____

**If your panel does not resemble any of the profiles to the right, provide a sketch on a separate page*

NEED A SPECIAL OVEREEZEE?

Our OverEZees are normally 3/8" to 1/2" taller than existing ribs. If you require a taller OverEZee for insulation or other reasons, please provide the below dimensions.

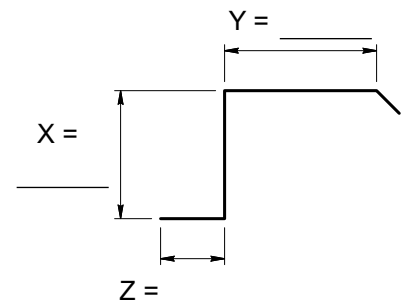

Contractor should verify the existing panel module (rib centers) is maintained at several locations of existing roof. Panel run-out may require adjustments to OverEZee punching. **This should be known in advance to get the best results.**

I hereby certify that the above dimensions are correct and complies with actual field obtained information.

Print Name (Please Print Clearly): _____ Date: _____

Signature: _____ Title: _____